



PRADO

AUTOMAÇÃO INDUSTRIAL

BEIJING

RUIZHITIANHONG S&T CO., LTD

ENGRAVING MACHINE MOTION CONTROL SYSTEM

A11: THREE-AXIS MECHANICAL CARVING

USER'S MANUAL



<https://pradoautomacaoindustrial.com.br>

email: vendas@pradoindustrial.com.br

(11) 5666-6461 / (11) 94242-8989 - WhatsApp

Thank you for choosing the products!

This manual helps you be familiar with the company's products, and get information about systems' components, configuration, etc.

This manual detailed knowledge of the system characteristics, operational processes, installation and commissioning, and safety precautions. please read this manual carefully before using the system and machine, which will help you make use it better.

Cautions

1. Use of this product is strictly prohibited in the strong interference, strong magnetic field environment. Operating ambient temperature 0-70 °C, working environment humidity 0-90% (non-condensing).
2. Insert U disk in the correct direction. Do not pull out 50-pin cable when system run.
3. Perform processing U disk file process, do not pull out the U disk to prevent the interruption of data transmission.
4. Strictly prohibited metal, dust, and other conductive substances enter the controller.
5. The machine shell should connect the ground wire to ensure the safety of the work and to prevent interference.
6. Prohibited unauthorized disassembly, no internal user repairable parts.
7. For long periods of time, please pay attention to the power outage, and retain.
8. Pay attention to water, dust, fire when using it.
9. Do not use the corrosive chemical solvents to clean the equipment.
10. Spindle motor bearing life and its speed is inversely proportional.
11. Graver is very sharp. Do not touch when it is running, in order to avoid injury; Do not use handkerchiefs, scarves contact it to prevent embroiled damage.

Important Notice

The Company shall not be responsible for any loss caused by improper using or breaking the correct operating procedures.



Beijing ruizhitianhong S&T co.,Ltd owns this manual final interpretation,the company reserves the right to modify all information in this manual, including data, technical details, etc..

Content

Foreword.....	1.
1. RichAuto system composition.....	3
1.1 system composition	3
1.2 Description of Each Component.....	5
1.2.1 Handle.....	5
1.2.2 Interface board.....	6
1.2.3 50pin data transmission cable.....	6
1.2.4 USB communication cable.....	6
1.3 Interface Board Shell Size.....	7
2. Handlebuttons introduction.....	7
2.1 Buttons introduction	7
2.2 Usage mode	8
2.3 Detail information for buttons function.....	9
3. Wiring Instructions.....	11
3.1 RichAuto interface board Description	11
3.2 Interface board I / O Description	12
3.3 Hardware Wiring.....	17
3.4 Commissioning of the Machine and Control system.....	22
4. Menu Description.....	22
4.1 Menu category	22
4.2 Menu details	23
4.2.1 Machine Setup.....	23
4.2.2 AutoPro Setup.....	29
4.2.3 System Setup.....	32
4.2.4 Operate File.....	37
4.2.5 Version View.....	38

5. Machine Operation.....	39
5.1 Return home	39
5.2 Import processing files.....	39
5.3 Manual processing Operation.....	39
5.3.1 Manual operation speed switching and adjusting.....	39
5.3.2 Manual processing mode.....	40
5.3.3 Manual testing input and output.....	41
5.3.4 Manual switch coordinate system.....	42
5.4 Automatic processing operation.....	43
5.4.1 Determine the origin of the workpiece.....	43
5.4.2 Choose processing files.....	44
5.4.3 Processing parameters setting.....	45
5.5 Processing operations.....	45
5.5.1 Speed ratio & spindle grade Adjusting.....	45
5.5.2 Pause & adjust position.....	46
5.5.3 Breakpoint processing & power down protection.....	47
5.6 Advanced Processing.....	48
PS1. System upgrade.....	55
PS2. Operations of Handle communicating with computer.....	56
PS3. Common problems and troubleshooting.....	57

✧ Foreword

● System Introduction

RichAuto is CNC motion control system independently developed by Beijing ruizhi tianhong and it can be widely applied to machinery, advertisement, woodworking, mold engraving machine, laser, flame, plasma cutting machine, and so on in the machine control field.

RichAuto make DSP as the core control system, High-speed processing operation is the microcontroller, PLC systems can't match; Use embedded structure, High degree of integration, Strong stability, easy to installation and operation; U disk support, Removable storage card reader, With USB Interface, High speed transfer, Plug and play the full realization of all work offline.

Characteristics:

1. System deploy standard X, Y, Z axis motion control method ,Support the rotation axis (C axis) control, Enables to switch the processing of surface and processing of rotation ; up extended to X, Y, Z, C four-axis motion control, Implementation four axis interlocking Control.
2. Multi I / O Point Control, there is eight input and output signals in every basic I / O signal node, Expansion I / O nodes can be expanded to 32 input and output signals.
3. Support the standard G code, PLT format instructions; support domestic and international mainstream CAM software, such as: Type3, Art cam, UG, Pro / E, Master CAM, Cimatron, Wentai etc.
4. Provide with power-down protection. Instantaneous power processing system to automatically save the current processing of information (file name, current line number processing, processing speed, spindle threshold), when power again machine moves back, the system automatically prompts the user to restore the processing before power down, the processing operations become more humanity.
5. Support breakpoint memory, file selection, processing. Save 8 different

breakpoint processing information.

6. Multi-coordinate memory function. Provide nine working coordinate system, the user can switch among the 9 coordinate, each coordinate system can save a process origin information.
7. Support online adjust spindle operating frequency. The spindle frequency from 0 to maximum frequency is divided into 8 thresholds; 1 - 8 threshold can be processed directly adjust up and down without suspend processing.
8. Support adjust speed ratio online. Users can adjust the speed ratio, to adjust the processing speed and empty running speed, speed ratio values from 0.1-1, Ascending or descending per 0.1 numerical.
9. Simply manual operate mode. In manual mode, the system provides three kinds of sports concluding continuous, step (crawl), distance, manual operation became more simple and convenient.
10. Identifies M code, F code and other development commands, can open a special code based on user needs.
11. Built-in 512 M memory.
12. Unique handheld form factor with one hand to hold. Own liquid crystal display and 16 button buttonboard , operate intuitive and flexible, no longer dependent on the computer, the full realization of full offline operation
13. Comes with USB communications port, file transfer efficiency can be directly read U disk, card reader file, Plug and Play.
14. Self-test function, the system comes with I / O port signal detection capabilities, ease of remote maintenance.
15. Processing with high-speed and smooth, support high subdivide, make sure processing with high accuracy and high speed.
16. Unique in Chinese-English to show double-interface, can be realized in switching Chinese and English show online.
17. Multi-language display. Support for Simplified Chinese, Traditional Chinese, English, Russian, French and other languages, can be customized according to

user needs.

18. System can support automatic dynamic upgrades, convenient to remote operation, remote maintenance.

- **1. RichAuto system composition**

- **1.1 System composition**

RichAuto control system contains the following parts: A hand-held motion controller(handle) ,a line adapter board(interface board), a 50-pin data transmission cable, an USB communication cable.

RichAuto accessorieschematic diagram



Hand- held motion controller



Interface board



50-pin data transmission cable



USB communication cable

● 1.2 Description of Each Component

1.2.1 Handle

As shown below, including 6 parts:



Handle

- 1) LCD: 128 * 64 resolution LCD display, to display the machine motion, system settings and other information.
- 2) Key Board: Contains 16 buttons to input system parameter information and operate the machine.
- 3) U Disk Interface: The port of U disk (FAT16/32) and the memory card.
- 4) 50-pin Data Cable port: The port of 50-pin data cable, it connect the handle with the interface board to realize controlling the machine.
- 5) Company LOGO.
- 6) USB Communication Port: The port of USB communication cable. It is used to connect the handle with your computer.

1.2.2 Interface board

As shown below, including 5 parts:

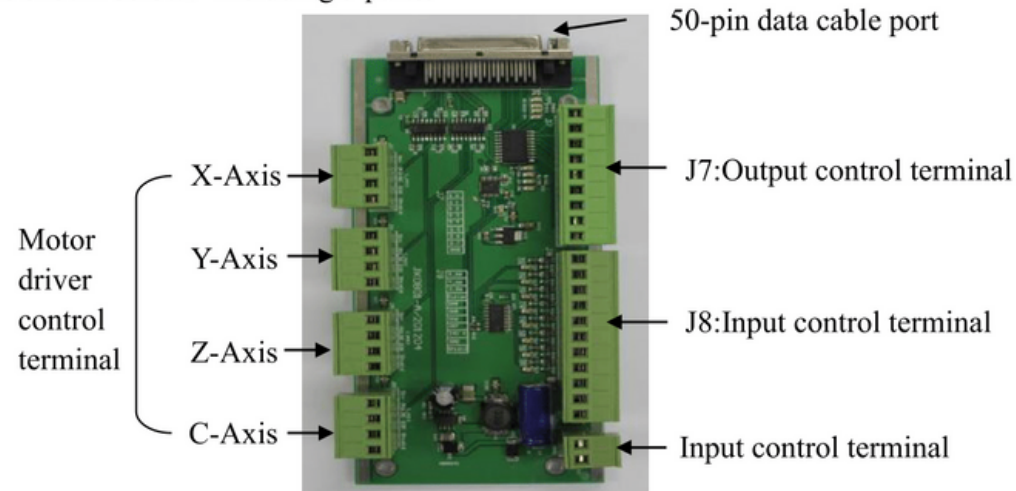

- 1) 50-pin data cable port: connect handle with interface board.
- 2) Output control terminal: including spindle On/Off signal, work&alarm led signal etc..
- 3) Input control terminal: including machine origin detection switch, toolsetting, driver alarm, hard limit switch, and E-stop signal.
- 4) Power supply terminal: DC24V,3A
- 5) Motor driver control terminal

1.2.3 50-pin data transmission cable



1.2.4 USB communication cable



- **1.3 InterfaceBoard Shell Size**

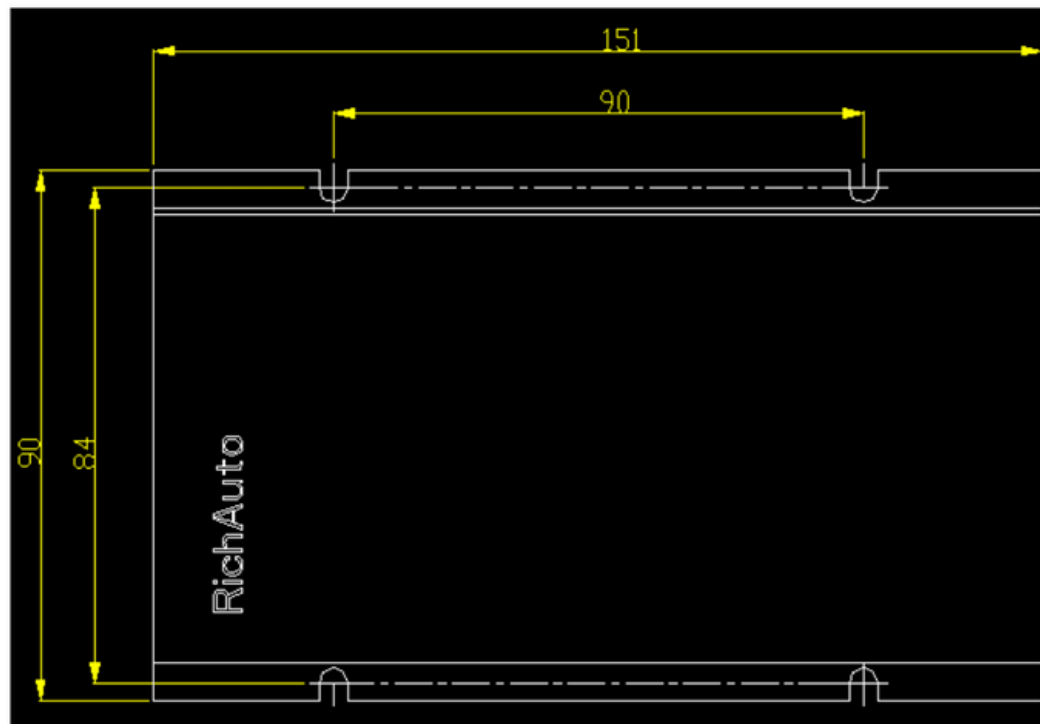

Scale: 1:1, Unit: mm

- **2. Handlebuttons introduction**

- **2.1 Buttons introduction**

RichAuto motion control system defines 16 buttons according to functional requirements. Each button has one or more functions under different work status.

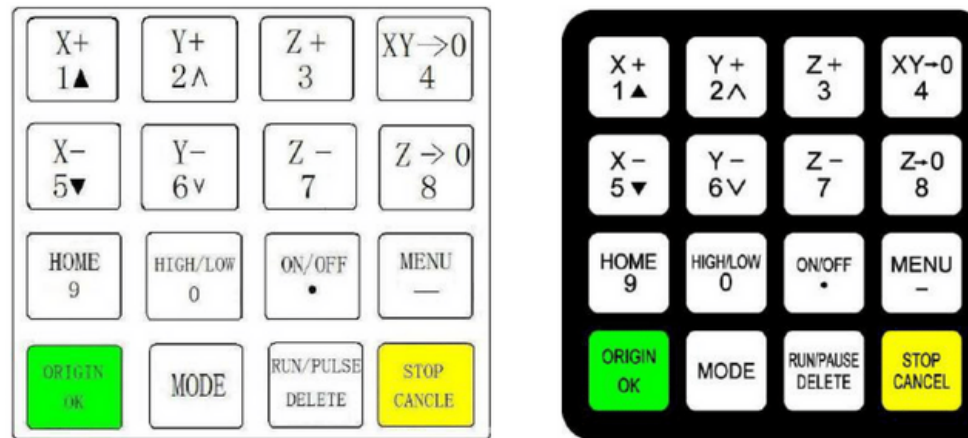

16-button layout_ buttons picture

● 2.2 Usage mode





RichAuto motion control system provide two modes of buttons' operations, including one-touch button & Combination button.

One-touch button: Press one button on handle.



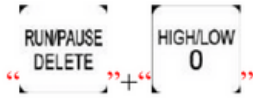
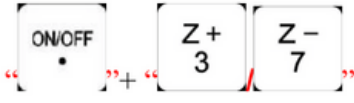
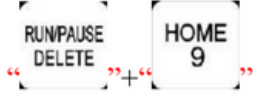

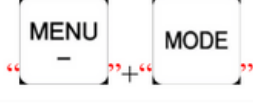
Combination button: Press two buttons at the same time to achieve the operation; the operation step: press one main function button and meanwhile press a second accessibility button, and then release the two buttons at the same time to realize the combination button operation.

List of Combination buttons:

	Combination button	Function
1	 “MENU -” + “0—9” Number Buttons	Switch the coordinate system (0 for the mechanical coordinate system , 1 - 9 for the work coordinate system)
2	 “MENU -” + “ON/OFF •”	Start Z-axis automatic tool setting
3	 “RUN/PAUSE DELETE” + “1—8” Number Buttons	Start the breakpoints processing (support number 1 - 8)

4		Start advanced processing
5		To switch gear shaft under manual mode
6		Repeat last time processing
7		Set stop position
8		System upgrade
9		Operate machine by entering coordinates parameters
10		Quit buttons check











● 2.3 Detail information for buttons function

Name	Function
	Positive movement of X axis, menu upward , figure 1 inputting
	Positive movement of Y axis, speed-up processing speed, figure 2 inputting
	Positive movement of Z axis, figure 3 inputting, increase spindle speed during processing
	Set X axis and Y axis work origin, figure 4 inputting
	Negative movement of X axis, menu downward, figure 5 inputting



PRADO

AUTOMAÇÃO INDUSTRIAL

	Negative movement of Y axis, slow down processing speed, figure 6 inputting different property selecting in Menu
	Negative movement of Z axis, figure 7 inputting, reduce spindle speed during processing
	Set Z axis work origin, figure 8 inputting
	Machine back home, figure 9 inputting, check information during processing
	High or low speed selection under manual mode, figure 0 inputting, change work coordinate & mechanical coordinate during processing
	Spindle start/stop, decimal point inputting
	Enter menu setting, negative sign inputting, check information during processing
	Back to work origin, confirm motions /inputting/operating
	Manual mode, continue/step/distance to select
	Run or pause processing, delete inputting data, different property selecting in menu
	High/low speed parameter adjust under manual mode, quit process stop/selections, inputting and operating cancel

➤ **3. Wiring Instructions**

● **3.1 RichAutointerface board description**

Interface board schematic diagram:



PRADO

AUTOMAÇÃO INDUSTRIAL

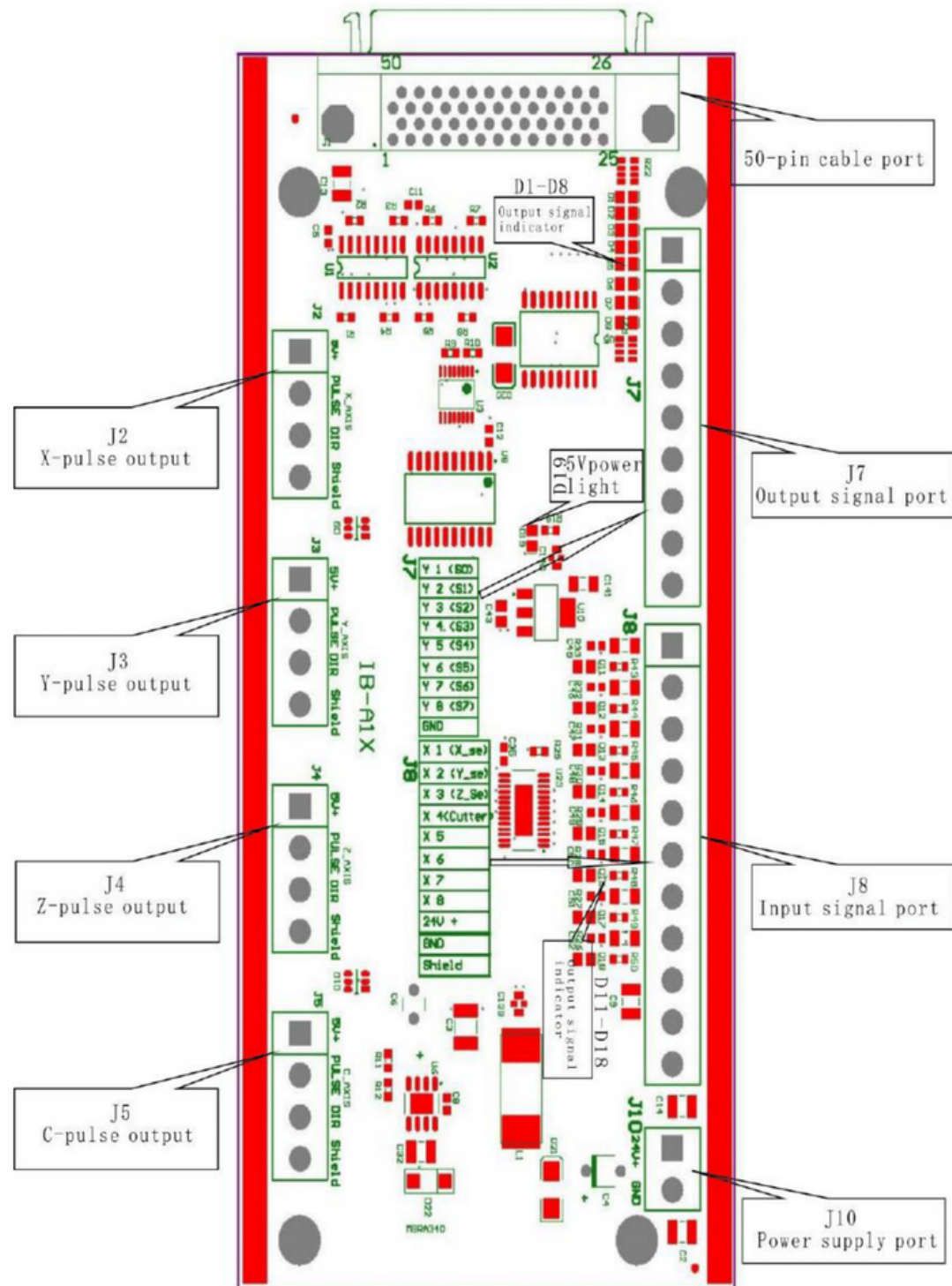

● 3.2 Interface board I / O Description

Port label	Port definition	Pin Definition	Pin functions and parameters	Notes
------------	-----------------	----------------	------------------------------	-------



PRADO

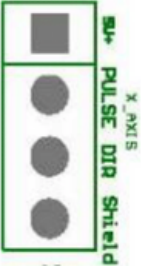
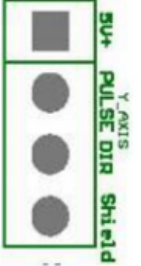

AUTOMAÇÃO INDUSTRIAL

<p>J10</p> 	<p>System Main power</p>	<p>System main power supply port</p>	<p>System main power supply terminal, interface board give DC 5V for system.</p>	<p>Power area : DC10V~D C24V/3A~4 0V</p>
<p>J2</p> 	<p>X-axis pulse output port</p>	<p>5V signal output port</p>	<p>X-axis drive common anode power supply terminal 5V output</p>	<p>Do not impose voltage on this pin</p>
<p>Pulse signal output port</p>		<p>X-axis drive pulse signal output port, the output voltage $\cong 3V$ drive current $\cong 8mA$</p>		
<p>direction signal output port</p>		<p>X-axis direction of the drive signal output port output voltage $\cong 3V$ drive current $\cong 8mA$</p>		
<p>Shield connection port</p>		<p>X-axis drive signal output voltage line terminal shield</p>	<p>Do not impose voltage on this pin</p>	
<p>J3</p> 	<p>Y-axis pulse output port</p>	<p>5V signal output port</p>	<p>Y-axis drive common anode power supply terminal 5V output</p>	<p>Do not impose voltage on this pin</p>
<p>Pulse signal output port</p>		<p>Y-axis drive pulse signal output port, the output voltage $\cong 3V$ drive current $\cong 8mA$</p>		
<p>direction signal output port</p>		<p>Y-axis direction of the drive signal output port output voltage $\cong 3V$ drive current $\cong 8mA$</p>		
<p>Shield connection port</p>		<p>Y-axis drive signal output voltage line terminal shield</p>	<p>Do not impose voltage on this pin</p>	
<p>Port label</p>	<p>Port definition</p>	<p>Pin Definition</p>	<p>Pin functions and parameters</p>	<p>Notes</p>
<p>J4</p>		<p>5V signal output port</p>	<p>Z-axis drive common anode power supply terminal 5V output</p>	<p>Do not impose voltage on</p>



PRADO

AUTOMAÇÃO INDUSTRIAL

	Z-axis pulse Output port	Pulse signal output port	Z-axis drive pulse signal output port, the output voltage $\cong 3V$ drive current $\cong 8mA$	this pin
		direction signal output port	Z-axis direction of the drive signal output port output voltage $\cong 3V$ drive current $\cong 8mA$	
		Shield connection port	Z-axis drive signal output voltage line terminal shield	Do not impose voltage on this pin
J5 	C-axis pulse Output port	5V signal output port	C-axis drive common anode power supply terminal 5V output	Do not impose voltage on this pin
		Pulse signal output port	C-axis drive pulse signal output port, the output voltage $\cong 3V$ drive current $\cong 8mA$	
		direction signal output port	C-axis direction of the drive signal output port output voltage $\cong 3V$ drive current $\cong 8mA$	
		Shield connection port	C-axis drive signal output voltage line terminal shield	Do not impose voltage on this pin

Port label	Port definition	Pin Definition	Pin functions and parameters	Notes
J8		X1:X_se: X origin sensor Signal Input	X origin sensor signal	Input low level signals



PRADO

AUTOMAÇÃO INDUSTRIAL

	Input control signal terminal		input terminal	
		X2:Y_se: Y origin sensor Signal Input	Y origin sensor signal input terminal	Input low level signals
		X3:Z_se: Z origin sensor Signal Input	Z origin sensor signal input terminal	Input low level signals
		X4:CutterTool-setting sensor signal input	Tool-setting sensor signal input terminal	Input low level signals
		X5 : Driver alarm signal input	Driver alarm signal input terminal	Input low level signals
		X6:Hard limit signal input	Hard Limit signal input terminal	Input low level signals
		X7 : E-stop signal input	E-stop signal input terminal	Input low level signals
		X8 : Definable signal	Definable signal input terminal	Input low level signals
		24V+: Sensor power input	X, Y, Z sensor isolate circuit power supply positive input terminal	Sensor isolate circuit supply voltage range DC10V~DC24V
		GND: GDN input	X, Y, Z sensor isolate circuit power supply negative input terminal	
		Shield: Shield input	Sensor signal cable shield input terminal	Do not use this port as a negative use of the sensor isolation circuit power

Port label	Port definition	Pin Definition	Pin functions and parameters	Notes
J7		Y1(S0):	Connect to	Output Low



PRADO

AUTOMAÇÃO INDUSTRIAL



	Output signal Control terminal	Spindle ON/OFF	FWD of inverter	level signal
		Y2(S1): speed 1	Connect to inverter to control speed	Output Low level signal
		Y3(S2): speed 2	Connect to inverter to control speed	Output Low level signal
		Y4(S3): speed 3	Connect to inverter to control speed	Output Low level signal
		Y5(S4): Alarm LED	Light when there is something wrong with system	Output Low level signal
		Y6(S5) : Work LED	Light when system works	Output Low level signal
		Y7(S6): definable	user-defined signal	Output Low level signal
		Y8(S7): definable	user-defined signal	Output Low level signal
		GND:Output GND		GND connect to this terminal in control inverter speed mode

Port label	Port definition	Pin Definition	Pin functions and parameters	Notes
------------	--------------------	-------------------	---------------------------------	-------



PRADO

AUTOMAÇÃO INDUSTRIAL

	D19	Power LED	Interface board 5V indicator indicate the interface and internal power supply status moderators	Lights after power
	D11	Status indicator	X origin status indicator	Light after power. Input low level signal, the lights will be put out. Release the signal, the lights will be bright again
	D12	Status indicator	Y origin status indicator	
	D13	Status indicator	Z origin status indicator	
	D14	Status indicator	Tool-setting Status indicator	
	D15	Status indicator	Driver alarm status indicator	
	D16	Status indicator	Hard Limit status indicator	
	D17	Status indicator	E-stop status indicator	
	D18	Status indicator	Definable signal status indicator	
	D1	Status indicator	output terminal Y1 status indicator	Output low level signal when the system works
	D2	Status indicator	output terminal Y2 status indicator	
	D3	Status indicator	output terminal Y3 status indicator	
	D4	Status indicator	output terminal Y4 status indicator	
	D5	Status indicator	output terminal Y5 status indicator	
	D6	Status indicator	output terminal Y6 status indicator	
	D7	Status indicator	output terminal Y7 status indicator	
	D8	Status indicator	output terminal Y8 status indicator	

● 3.3 Hardware Wiring

Installation Requirements: Power (24V, 3A), it is better to add a filter to prevent

the electric field interference. If origin detecting switch are different power supply type, the special testing switching power is needed. (24V origin detecting switch is the best choice)

RichAuto motion control system realizes its control through the connection between the interface board and CNC machine. Interface board terminal can be divided into input terminal and output terminal:

Input terminal:

J8 (input control terminal)

J10 (main power terminal)

Output terminal:

J2 (X axis pulse signal output terminal)

J3 (Y axis pulse signal output terminal)

J4 (Z axis pulse signal output terminal)

J5 (C axis pulse signal output terminal)

J7 (output control terminal)

Input signal terminal

J8

1. sensor input: a) Mechanical: Y and Z are the same as X

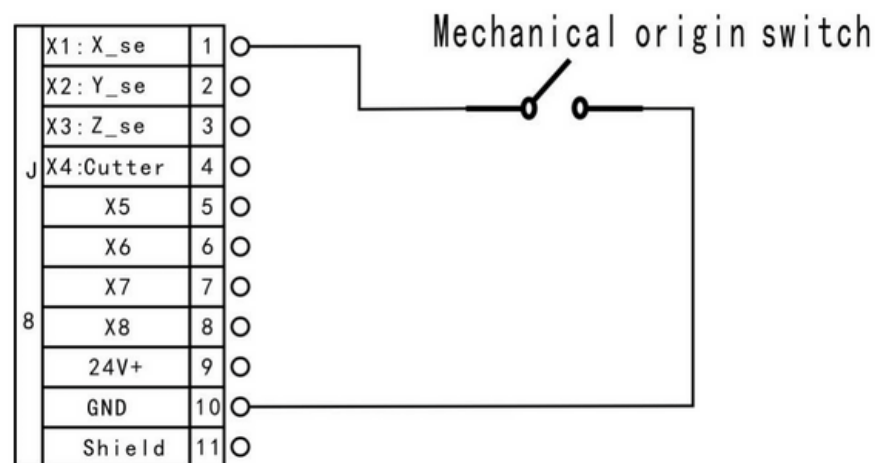

b) NPN(NO): Y and Z are the same as X

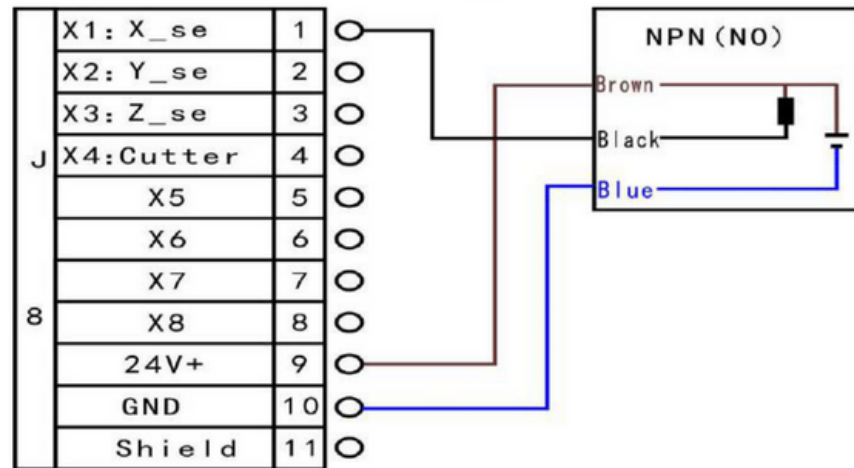

c) PNP(NO) : X and Z are the same as Y

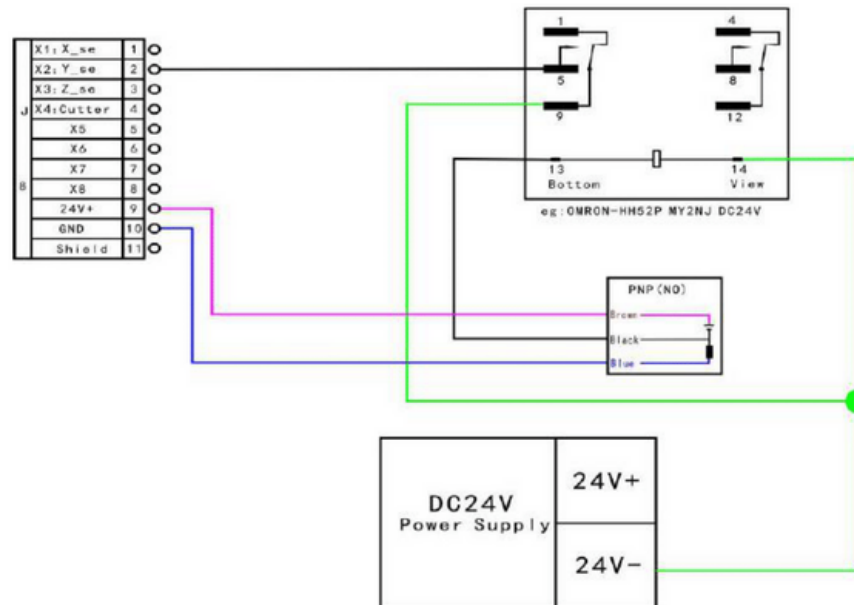

2. Tool-setting input: Tool-setting detecting wiring:

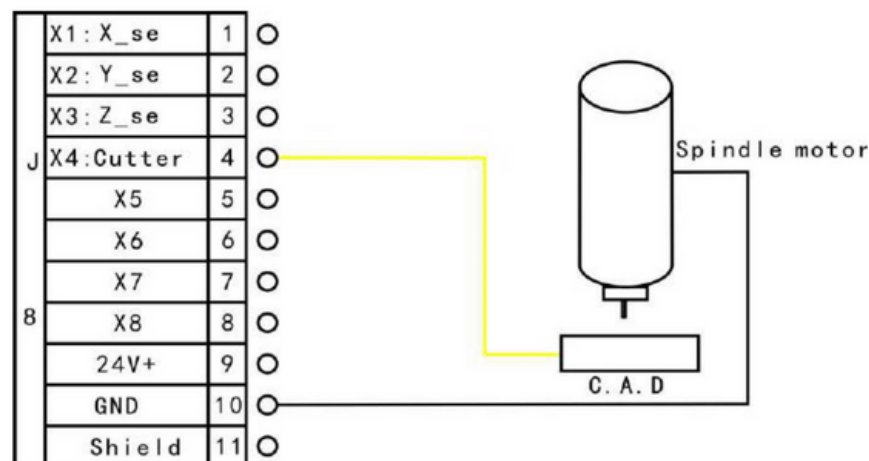

3. X5-X8 Driver alarm, Hard limit, E-stop signal

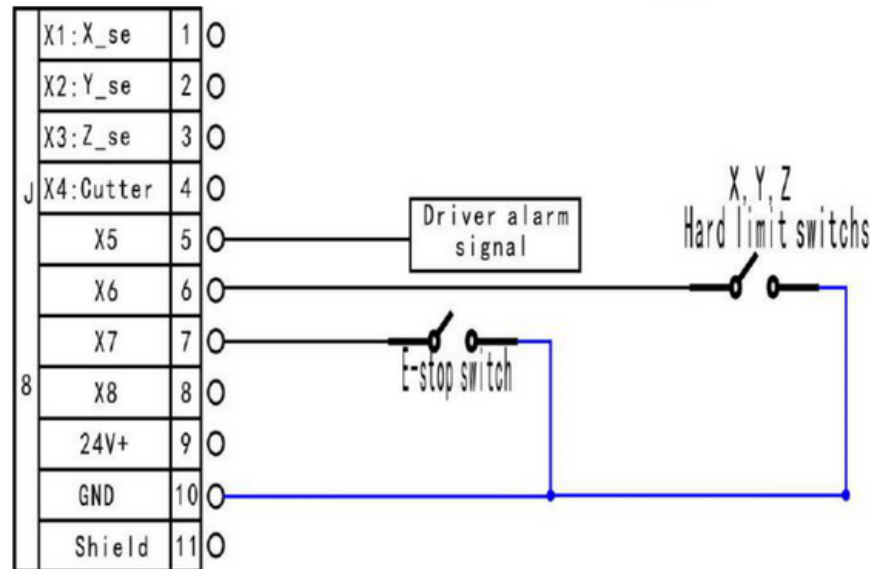

J10 Main power wiring:

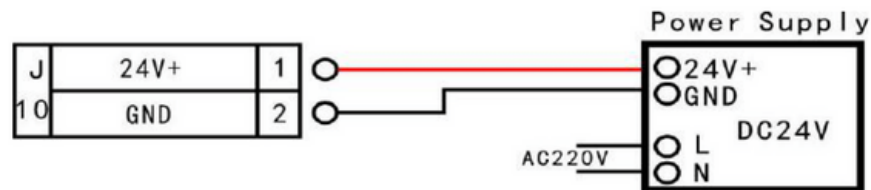

Output terminal

J2 X pulse signal wiring: Y and Z are the same as X

Stepper driver:

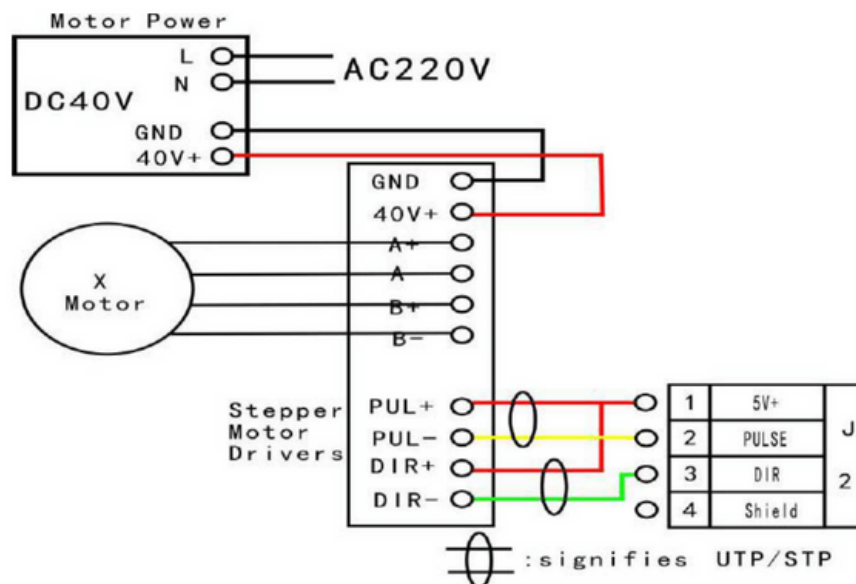

Servo driver:



PRADO

AUTOMAÇÃO INDUSTRIAL

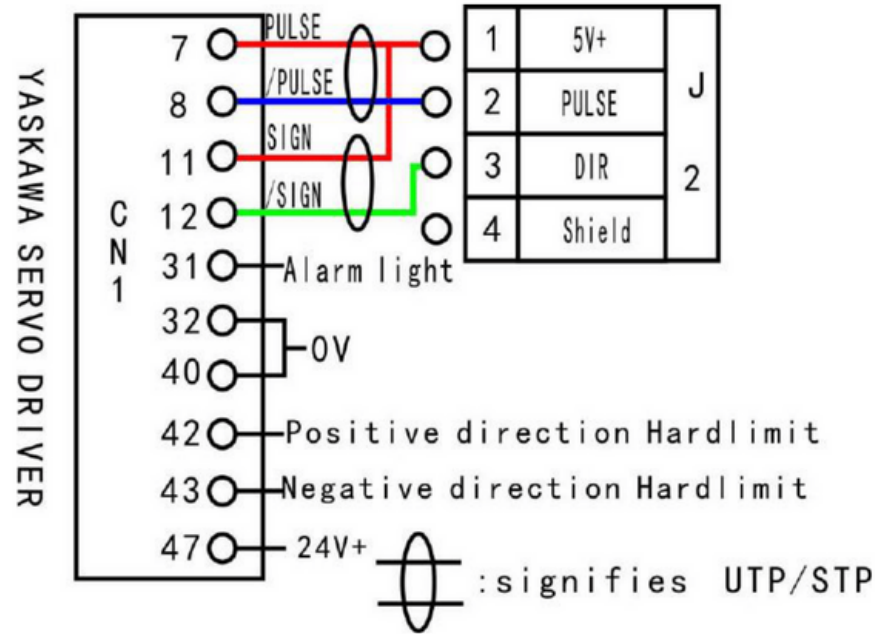

J7 Spindle output

2 status : spindle start/stop

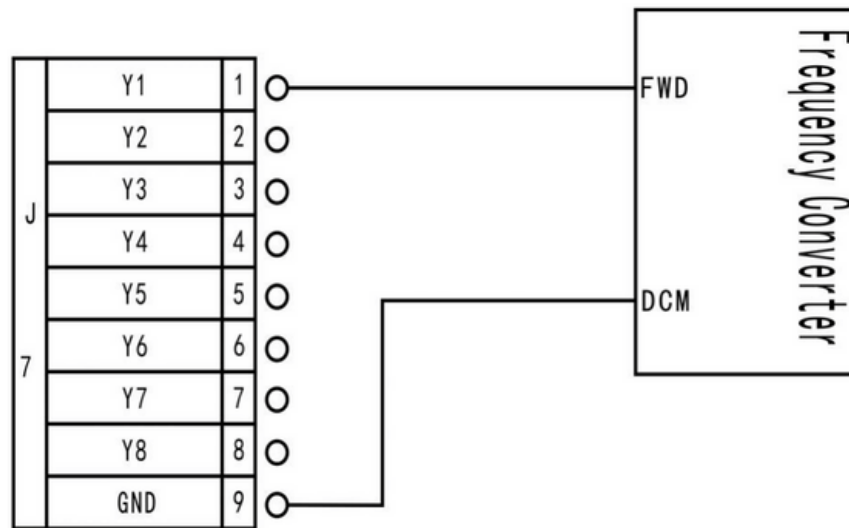

the corresponding spindle setting is:

1 Shift	↓
2 Shift	↑

8 status : spindle start---S1—speed 1 ,S2—speed 2 ,Sn—speed n ,when spindle stop ,

the screen displays Fn—the speed before spindle stop.

3 lines,8 status

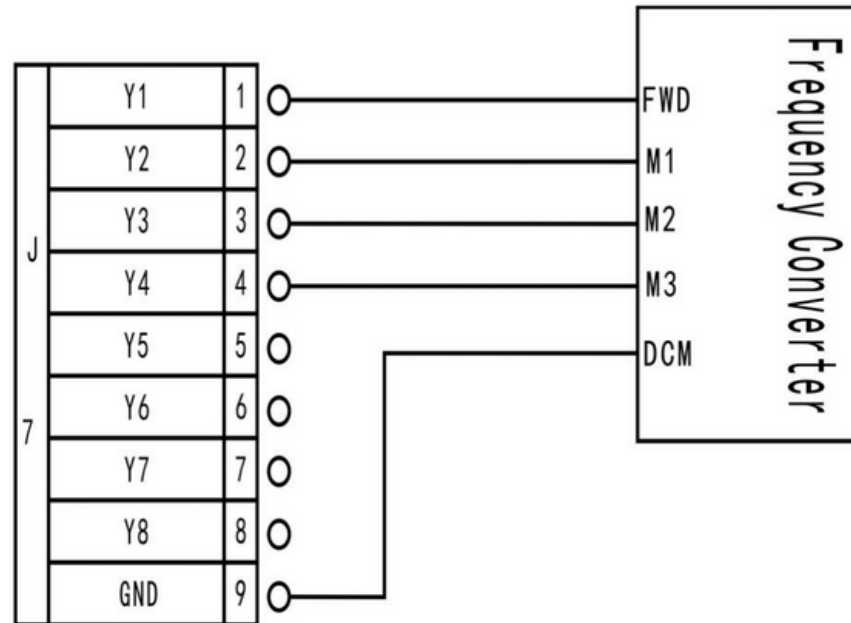

the corresponding spindle setting is:

1 Shift	↓	↓	↓
2 shift	↑	↓	↓
3 shift	↓	↑	↓
4 shift	↑	↑	↓
5 shift	↓	↓	↑
6 shift	↑	↓	↑
7 shift	↓	↑	↑
8 shift	↑	↑	↑

PS: FWD and DCM has Connected in Parallel in some inverters, please do not need to connect Y1 (S0) in such situations, you only need to connect DCM with GND of interface board, without having to reset the spindle gear.

J7 Output port Y5-Alarm LED and Y6-WORK LED:

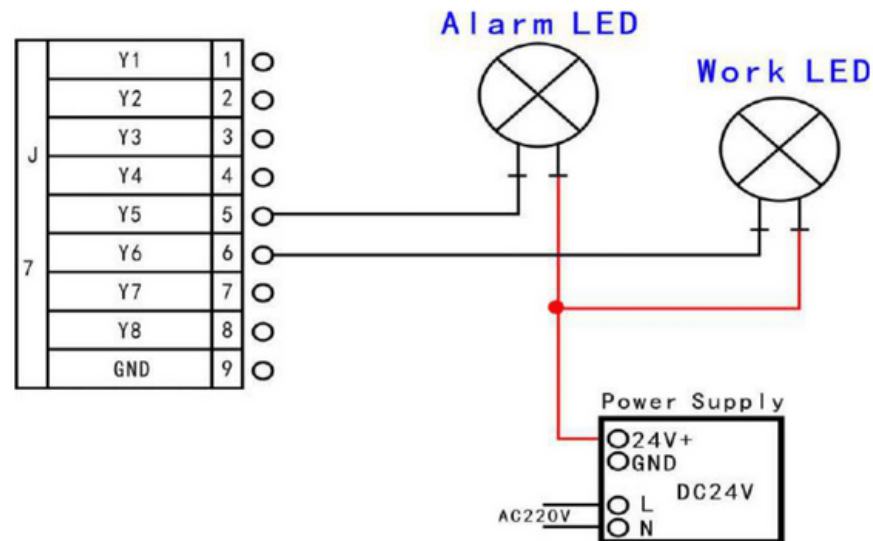

You can connect the machine with the control system when the above setting is over.

● 3.4 Commissioning the Machine and Control System

- 1) After turn on the power, users can manually move each axis and confirm the direction. If the movement direction and definition direction are opposite, users can change the motor phase sequence.
- 2) According to the original location of the machine coordinates, users can enter into menu-machine setup-home setup- home direction to reset it.
- 3) Double-press “menu”-manual voltage setup (the upper arrows stand for input voltage) to check whether the home switch is working.

The machine is in good connection if all the above setting is ok.

➤ 4. Menu Description

● 4.1 Menu category

According to menu function, RichAuto system menu divided into: **MACHINE SETUP, AUTO PRO SETUP, SYSTEM SETUP, OPERATE FILE, VERSION VIEW**. Every main menu has some submenus.

● 4.2 Menu details

4.2.1 Machine Setup

Users can set the parameters about machine hardware under "Machine Setup". It is set by machine producer according to device type. If machine hardware parameter is not changed, this parameter should also not change. If machine users need to change, please consult machine producer.

Machine setup chart

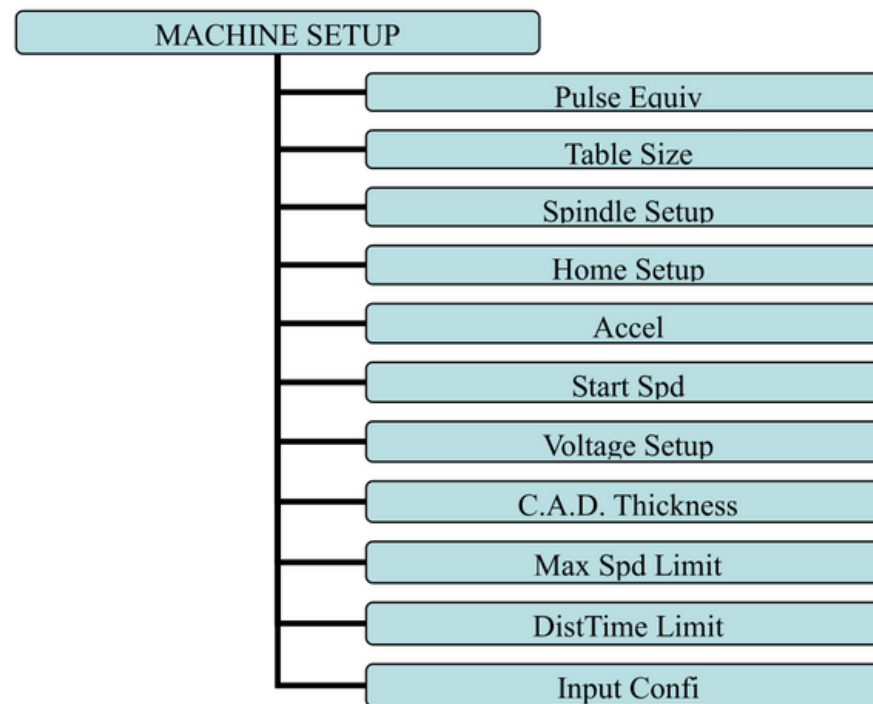

1. pulse equiv(Pulse Equivalent)

The number of pulses of the system needs to send when machine moves every 1mm. Unit: pulse/mm.

1) stepper driver

Formula = pulses per revolution / distance per revolution

Pulses per revolution formula: $(360^\circ/\text{stepper angle}) * \text{Driver subdivision}$

Some stepper drivers mark pulse number directly.

Distance/r formula:

Screw drive machine = screw pitch * mechanical transmission ratio

Rack drive machine = rack module * gear teeth number * π * mechanical transmission ratio

So stepper motor system formula:

✓ Screw drive



$$\text{pulse} = \frac{360^\circ}{\text{Stepper angle}} * \frac{\text{Driver subdivision}}{\text{Screw pitch} * \text{transmission ratio}}$$

Formula Description: step angle is the angle of the motor parameters, motor rotation step walk.

Driver subdivision is the parameter set by the driver.

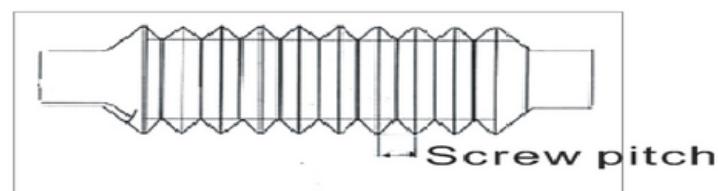

Screw pitch(above picture): The distance that the nut moves when the ball screw makes one rotation.

Transmission ratio: The speed ratio or angular velocity ratio of the capstan and the driven wheel.

✓ Rack drive



$$\text{pulse} = \frac{\frac{360^\circ}{\text{stepper angle}} * \text{Driver subdivision}}{\text{rack module} * \text{gear teeth number} * \pi * \text{transmission ratio}}$$



Formula Description: step angle is the angle of the motor parameters, motor rotation step walk.

Driver subdivison is the parameter set by the driver.

Rack module and gear teeth number are gear parameters. rack module * gear teeth number* π equals the perimeter of the reference circle.

Transmission ratio: The speed ratio or angular velocity ratio of the capstan and the driven wheel.

Setting: Enter “pulse equiv”, cursor is in the X-axis pulse equivalent position, press

“”, “” to move cursor to where users want to modify. Press “”,

input the new number, and press “” to save, cursor auto move to next line, the

same operation to change, press “” to save all value.

2) servo driver

The pulse equivalent factory default X,Y,Z are 400, and set the electronic gear ratio in the servo drive according to the pulse equivalent.



The numerator of the electronic gear ratio represents recorder pulse number, users can search it in servo driver manual.

The denominator of the electronic gear ratio

- ✓ screw drive: Handle pulse equivalent $(400) * \text{screw pitch} * \text{mechanical transmission ratio}$
- ✓ rack drive: Handle pulse equivalent $(400) * \text{rack module} * \text{gear teeth number} * \pi * \text{mechanical transmission ratio}$

2. Table Size

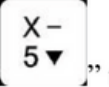
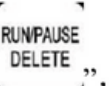
RichAuto system make the table size as the soft limit values, in order to prevent machine move over travel, machine size must be less than or equal to the value of the actual motion displacement machine.

Setting: Enter “**Table Size**”, press “”/“” to move cursor to where users want to modify. Press “”, input the new number, press “” to save, cursor auto move to next line, the same operation to change, press “” to save all value.

3. Spindle Setup

Spindle delay: Unit: ms; including start delay and stop delay.

Spindle state: Used to set system using multi-speed or only on/off 2 status, the corresponding system parameters. System default “3-line 8-state”, if users need “1-line 2-state(On/Off)”, users can change the number of lines is 1; See detailed settings at [J7](#) spindle output wiring.

4. Home Setup

Home speed: Every axis movement speed when back home, system default speed X,Y: 3000 MM/Minute, Z: 1800 MM/Minute.

Home order: Every axis movement order when back home

Including:

- ◇ Z,X and Y Z,X,Y Z,Y,X
- ◇ Z only X and Y,Z X,Y,Z
- ◇ Y,X,Z XY home X,Y home
- ◇ Y,X home None home X home only XZ and Y

Home direction: Every axis movement direction when back home, this direction depends on the position where home switch is on the machine. If home switch installed in the positive direction, so home direction should be “**positive**”, and vice

versa.

Setting: Enter "home dir", press "X+ 1▲"/"X- 5▼" to move cursor to where users want to modify. Press "RUN/PAUSE DELETE" to change home direction, press "ORIGIN OK" to save the change.

5. Accel / Acceleration Unit: mm/s²

— The maximum acceleration value during acceleration and deceleration movement, improve (including straight and curved motion) processing capabilities. If acceleration is too large, it may cause the motor losing steps, jitter and even whistle, if too small, it will lead to accelerated slowly and reduce the operating speed of the entire graph. System default: linear acceleration is 800 mm/s², curve acceleration is 1000 mm/s², the proposed curve acceleration is 1-1.5 times the linear acceleration value.

6. Start Speed Unit: mm/minute





— The speed of axis started directly from standstill. Not starting from zero speed, but starting directly from a certain speed, so it can shorten the overall processing time, but do not set this speed too high. Set too high, it will cause the motor losing steps, jitter and even whistle; Set too small, it will reduce the operating speed of the entire graph. If the inertia of motion axes (axis heavier), users can set a smaller start speed, if the inertia of motion axes smaller (lighter shaft), users can set it bigger.

7. Voltage Setup

Set input and output signal terminal status, "↓" means normal open, "↑" means normal closed. Including two rows of arrow:

The upper arrow indicates the input level: Set input voltage signal terminal status. The top four: 0、1、2、3 positions correspond X axis back home、Y axis back home、Z axis back home、toolsetting signal, 5-7: 4、5、6 positions correspond driver alarm, hard limit E-stop signal.

The under arrow indicates the output level: Set output voltage signal terminal status. The top four: 0、1、2、3 positions correspond spindleOn/Off、multi-speed 1、multi-speed 2、multi-speed 3 signal, 5、6:4、5 positions correspond alarm LED、work LED signal.

Setting: Press “” / “” to move around, Press “”、
“” to move up and down, press “” to change the direction of the arrow.

8. C.A.D. Thickness Unit: mm

This thickness should input by actual, if it is bigger than the actual thickness ,Z axis may cut too much;if smaller, Z axis can't touch workpiece. This parameter can only take effect when user use auto toolsetting function.

9. Max Spd Limit (Max Speed Limit): Unit: mm/minute

Set machine top speed, it only take effect during processing, system default max speed X,Y is“60000000 mm/minute”, “Z+” is “1800 mm/minute”, “Z-” is “3000 mm/minute”.

10. DistTime Limit Unit: second

Users select distance mode,and if the machine does not move in a certain period of time(system default is 30 seconds),the system will go back to continuous mode to prevent Z-axis collision risk because of the customer forgot to switch back to continuous mode and set a large distance value.

11. InputConfi (Input Port Configuration)

To open or prohibit input signal, if the interface board does not connect X5-X8 signals,users can prohibit X5-X8 signals.

4.2.2 Auto Pro Setup

Users can set processing parameters,G code attributes etc.under this menu.

Auto ProSetupchart

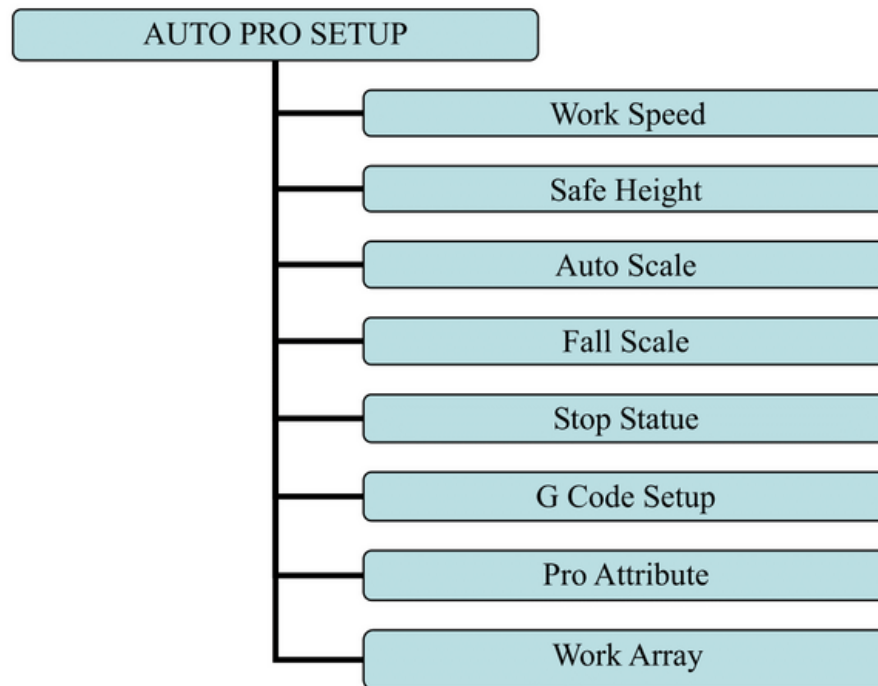

1. **Work Speed Unit: mm/minute**

Including work speed and fast speed,system default is 3000 mm/minute.

2. **Safe Height Unit: mm**

The height of Z axid rise during processing. system default is 40.000 mm.

3. **Auto Scale**

Actual processing speed=work speed*auto scale, system default auto scale does not affect the fast speed.

4. **Fall Scale**

Fall scale , system default is 0.200.fall speed=fast speed*fall scale , the

maximum fall speed is Z axis negative limit speed*fall scale.



Fall height, system default is 5.000mm, fall down scale takes effect when the spindle falls to the fall height.



5. Stop Statue

Setup stop position after auto processing.

Work stop state	
FinAct	Pickup
XCoordnt	0.000
YCoordnt	0.000
ZCoordnt	0.000

(Coordnt=coordinate)



Set stop position Press “” / “” to move cursor to where users

want to modify. Press “”, input the new number, press “” to save.

Press “” to enter finish action list:

FinAct
Pickup Z
Back To Work Org
Back Home
Back Positi
None move

(FinAct=Finish Action, Org=Origin)

Press “” / “” move cursor to where users want to modify, press

“” to save



6. G Code Setup



Set special G code attribute, according to the actual need to make changes.

Attribute Of G Code	
F Read	Ign F/ReadF
AbsCntr	On
T Read	Ign T/ReadT
Spindle	NTLLGFORCE/INSTR
FilterJD	None/Adj Z Filter
S Read	Ign S/ReadS
Read G54	Ign G54/ReadG54
Read G49	Ign G49/ReadG49
Read G40	Ign G40/ReadG40
CodeHead	Sk/NoSkip
Input TO	-1

(Ign=Ignore, Adj=Adj=Adjust, AbsCntr= Absolute center)



PS: Blue parts indicate system default attributes.



Setting: Press “”/“” move cursor to where users want to modify,

press “” to select the attribute users want, press “” to save.

7. ProAttribute

Work attribute	
Adj Z	Adj Z/Rev Z
Adjust WP	NonAdj
Ignore Z	Read Ign Z
CirLmt	55.556
StepWork	ContrSingle
ATC Spld	AutNone

Setting: Press “”/“” move cursor to where users want to modify,

press “” to select the attribute users want, press “” to save.

8. Work Array:

Set array parameter, including columncount、Rowcount、Columnspace、Rowspace、Interval (unit: ms)

Columnspace: File spacing of X direction

Rowspace: File spacing of Y direction

Total Processing times= columncount* Rowcount

Interval: System default 0, it means no wait.

During processing, if users need to change processing materials after completion of each processing, you need set time interval a negative number. When the first time processing is completed, the screen prompt: waiting for the next array processing, press any key to start the next array processing at this time, if not press, system keep waiting.

4.2.3 System Setup

System Setup Chart

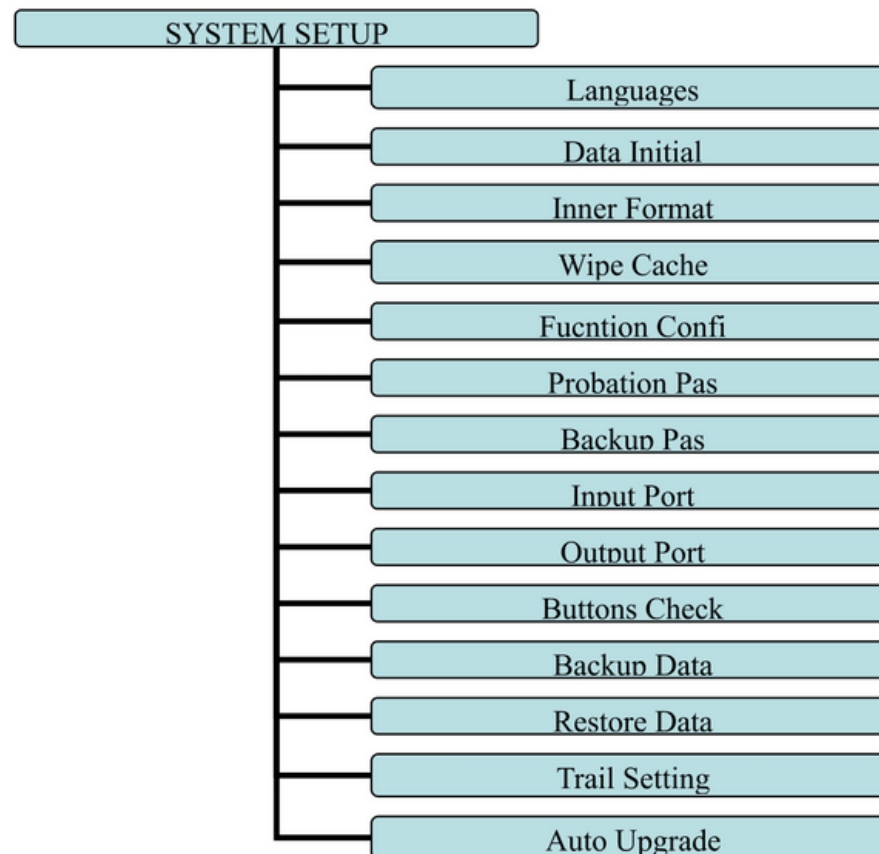

1. Languages

Change system display language, users can choose Chinese and English.

2. Data Initial:

After data initial system parameters will restore to factory setting.

3. Inner Format

Wipe the internal files, it will not damage the system parameters.

4. Wipe Cache





Users need to do this after functional upgrade, such as change four-axis program to three-axis program, users must do this operation. After this operation, users need to restart the system.

5. Function Configuration

Set whether the system retain a function or not, change it according to the actual application in accordance with the practical application of changes. After the operation users need to restart the system.

Set function	
PausePkup	NoPickup
ScaleFast	NoAffect
Manual	Stop/Trad
Pretrt	ParseNone
QuryPara	QueryNone
StrtHome	QueryAuto/ZOnly/None
CopyWork	Off/On
RetOrgPZ	Pick/Z Stop
TolstAct	PickupOrigin
PauseRstr	Only Z

PS: Blue parts indicate system default function.

Setting: Press “”/“” move cursor to where users want to modify, press “”, and then select the function users want, press “” to save.

6. Probation Pas/ Probation Password:

If engraving machine manufacturers setting some kinds of passwords before shipment(including probation password and backup password, etc.), if you forget the original password, you can connect our company and tell us 20-digit here, our company will provide you a new 20-digit password, you need enter the new 20-digit password, and then all the passwords will be cracked.

Setting: Press “” to enter “Probation Password”, input the new password,

and then press “” to save.

7. Backup Pas/ Backup Password

Prevent users overwritten the original correct parameters in the parameter backup disorder or misuse case. To cancel, you do not input any number when you are

prompted to enter a new password, press “” to save.

8. Input Por(Input Port List):

1-3:X,Y,Z home signal 4: Tool setting input signal

5-7:Driver alarm,Hard limit,E-stop signal

9. Output Por(Output Port List):

1: Spindle On/off signal 2-4: Spindle speed signal 5: Driver alarm signal

6: Work LED signal

10. Buttons Check

Users can check buttons are valid or not under this menu.Enter “Buttons Check”, press every button, if it is valid, the screen will highlight.Exit “Buttons

Check”, press “” + “”.

11. Backup Data

Backup system parameters to U disk or inner, format system can't effect this. File format: **data.bak**.







12. Restore Data

Restore backup data from U disk or inner to system.

13. Trial Setting

Including Four levels password, password and using time can be set in every level respectively. Password can be set to be 1-8 digits; using time unit: hour, system default 1. The password work according to top-down order, if you do not set trial 1 password, only set trial 2-4, it will work according to 2-4 order.

The operation of Data Initial、Inner Format、Wipe Cache should not crack the password.

Setting Press “” to get into “**Probation Set**” press “”, “” to move cursor to which you want to choose. Press “” to get into, and then press “”, input the new number, press “” to save. The screen display:

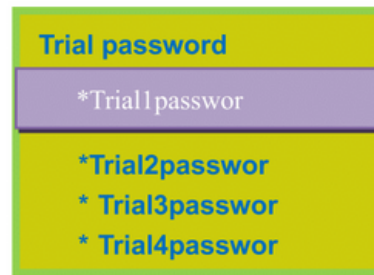

There is a mark “*” before every level password, if not, the password will not work normally.

If you have setted all passwords, press “”, the screen will display:

You must restart the system after setting trial password.

When password expires, the screen will display:

The system is out of testing time, please contact the factory to get more testing time or unlock!

ORIGIN
OK

Connect engraving machine manufacturers to get password, press “ORIGIN OK”, the screen will display:

Please input trail 1 password:

ORIGIN
OK

Enter the password, press “ORIGIN OK” to save. The screen will display:

The time password is updated successfully, please restart the control system.

Restart the handle, and system will work normally.

NOTE: If engraving machine manufacturers forgot all password, you can contact our company and tell us 20-digit original password under “SYSTEM SETUP-Probation pas”, we will provide the new 20-digit password, entered the new number, and press

“ORIGIN OK” to confirm.

After Cracking Password, restart the handle, and then you can work normally.

14. Auto Upgrade

If the system has new function, our company will provide upgrade file (extension *****.PKG & shown as rz-xxxx), users can upgrade through the U disk, specific steps in Appendix 1. It will not damage the original parameters.

File format:  P1_1025(普通三轴雕刻[3寸单色屏][USB1]).pkg

4.2.4 OperateFile

OperateFile Chart

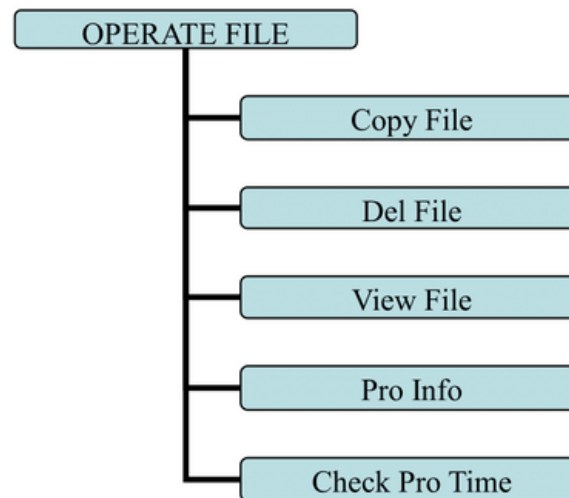

1. Copy File

Copy files from U disk to Inner.

2. Del File (Delete File):

Delete files of inner.

3. View File

View the files and G codes of U disk or inner.





4. Pro Info (Processing Information)

System power on, it will statistical the times of successful processing by file name, if system power off, the data will disappear.

5. Check Pro Time (Check Processing Time)

— Calculate processing time by system work speed, after reading G code, the screen will display the processing time, different work speed corresponding to

different processing time

Operation Method : Press “”, enter “Check Pro Time” ,
 press “”/“” to select “Udisk/Internal/Recent File”, press “” to enter,
 and then select the file, press “”, after reading G code, the screen will display the processing time.

PS: Please pull out the U disk correctly after copying files from computer, if not, the controller may not recognize the U disk.

1. Win7(32 bit) system: after copying files, please press “”, and then the display

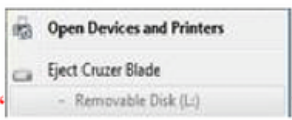
will show “”, choose the device to be shut down. when the display show

“”, the U disk pull out from computer successfully.

2. Win XP system: after copying files, please press “”, and then the display will

show “”, choose the device to be shut down. when the display show “”, the U disk pull out from computer successfully.

4.2.5 Version View

Users can view information about the system hardware and software, including:

- ✧ Update Version eg: P1.409/rz-xxxx/q10-82
- ✧ Product ID eg: A0020112
- ✧ Soft Version eg: A1.1936

- ✧ Emergency Version eg: A1.1920
- ✧ Soft type: 3-axis carving
- ✧ Hardware type: Support 3-inch screen Flash Disk Mode

➤ 5. Machine Operation

● 5.1 Return home

It will display “**all axis home**”, “**Z home only**”, “**none axis home**” after starting up the DSP handle. Choose any one you want. Machine return home can correct the coordinate of system.

In some cases, such as after normal power off, reboot and continue last operation, user no need to reset machine, just choose “**none axis home**” That is because system auto save coordinate value when system quit.

● 5.2 Import processing files

Before processing, generally we should import files. RichAuto system has 2 ways for processing: U disk file processing, inner file processing.

1. Directly import the processing file into U disk, then run the handle.
2. Copy the process file to inner memory space via U disk.

● 5.3 Manual processing Operation

Manual Processing Operation refers to controlling of the machine tool through keyboard. User can change the operate speed and set the grid under manual processing operation. System will enter Manual Operation state after returned home, and the screen displays:

Manual control state initial interface:

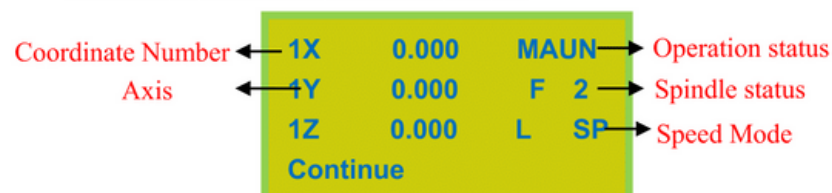

Manual Mode ←

5.3.1 Manual operation speed switching and adjusting

1) Speed modes switching



There are two speed modes: high speed and low speed. We can change mode by



press “”. The speed mode you choose will decide the processing speed.

2) Speed adjusting:

In manual mode, press “” to set the current speed mode. If the current speed is low speed, it displays as follow:

Manual Param	
X SLOW	1200000
Y SLOW	1200000
Z SLOW	1200000
Slow Grid	0.100

Press “”, “” to move the cursor, then press “” button to

modify the value, press “” to save, press “” to quit. If input a wrong

number, press “” to delete the last number.

In order to ensure the accuracy of processing and debugging, the system introduces the concept of grid which also called minimum feed. Its range is 0.05mm-1.0mm. When user change mode to “step”, machine will move by grid distance.

High speed mode setting is the same as low speed mode.







5.3.2 Manual processing mode

In order to meet different situations of manual movement, the system provides 3 kinds of motion modes: Continue, step, distance. We can change mode by pressing

“MODE” and the bottom of screen will display what the current manual mode is.

1) Continuous motion mode

This mode has no value control. In continuous mode, machine will follow when

press the direction button  ,  ,  ,  ,  ,  . Its motion speed is decided by current speed mode.







Note If users release the button immediately after pressing the button (shorter than 0.5s), machine will automatically move to the nearest grid point. It always stop on grid point when the motion mode is over. Continuous mode suitable for crude regulation of machine coordinate situation.

2) Step motion mode

This mode is always move in low speed, move 1 grid per 0.5 second. The grid distance is decided by current speed mode. This motion mode is suitable for tool adjusting or precise adjustment of the location of the mechanical coordinates.

3) Distance motion mode

In this mode, it runs according to the setting of distance. Machine will move by

the set distance when user press direction button  ,  ,  ,  ,  ,  .

Note Grid unable to affect the distance motion mode. Machine will move by set distance, can't move to grid point. If user wants to change distance, please change to distance mode and re-enter the distance value.

5.3.3 Manual testing input and output

In the initial boot interface, that is screen displays as follow:

1X	0.000	MAUN
1Y	0.000	E
1Z	0.000	L SP
Continue		



Press “” twice, the screen will displays two rows of arrows which are defaults to all arrows are downwards “↓”.

Upper arrows represent input signal: the former 4 numbers 0, 1, 2, 3 corresponding to X zero, Y zero, Z zero and tool setting gauge. 4,5,6 corresponding to driver alarm, hard limit and emergency stop input signal.



Manual trigger the corresponding signal switch by pressing “” and the corresponding arrow flip so the signal is normal.

Bottom row represent output signal: the former 4 number 0,1,2,3 corresponding to spindle on/off、 multistep rotational speed one、 multistep rotational speed two、 multistep rotational speed three output signal.4, 5 corresponding to alarm lamp、 running lamp output signal.



Press “” button can change the arrow direction, so it can control the



output of corresponding port. For example, press “” to flip the arrow upwards



under 0, it is equivalent to start the spindle. Press “” again, the arrow flip downwards that is equivalent to stop the spindle.

5.3.4 Manual testing input and output

Including **machine coordinate system** and **work coordinate system**.

Machine coordinate system is fixed, the origin of coordinates is always a fixed position relative to the machine; Its coordinates is called mechanical values, the origin of coordinates is the origin of the machine or reference point. so that at any time, one point of space can be confirmed by machine coordinate system. Because of reference point is the calculation basis of machine coordinates movement, powered on or

remove all abnormal states , you need back to zero.

Work coordinate system used more greatly than other coordinates system in processing. Usually in processing, we describe a processing position is always relative to a certain point on the workpiece, whereas the workpiece on the machine tool's position relative to the mechanical origin is often change, so it is necessary to introduce a set of more convenient coordinate system during processing, this is work coordinate system. The origin of work coordinate system is a fixed point relative to the workpiece, but relative to the origin of machine coordinate system is floating.

RichAutoA11 provide a machine coordinate system and eight work

coordinates system, press “” + “” can switch machine coordinate system

and work coordinate system, “” + “NO.button1-8” can switch machine coordinate system and eight work coordinates system.

Coordinates system:

AX	0.000	MAUN	1X	0.000	MAUN
AY	0.000	S 2	1Y	0.000	S 2
AZ	0.000	L SP	1Z	0.000	L SP
Continous			Continous		
Machine coordinate system			Work coordinate system1		
2X	0.000	MAUN	8X	0.000	MAUN
2Y	0.000	S 2	8Y	0.000	S 2
2Z	0.000	L SP	8Z	0.000	L SP
Continous			Continous		
Work coordinate system2			Work coordinate system8		

NOTE: You can not set work origin under machine coordinate system, switch to work coordinate system to set work origin.

● 5.4 Automatic processing operation

Auto processing refers to the system runs the file in U disk or inner storage

space according to the instruction, it also called file processing. Before auto processing, user must set the machine tool parameters and all of the system parameters correctly.



Auto processing steps:

5.4.1 Determine the origin of the workpiece

The origin coordinates of X, Y and Z in the processing program is the origin of the workpiece . Before operation, we should pay attention to this position as well as the real position. Operation is as follow:

Move X, Y and Z to the position which will start to process the file on workpiece. Afterwards, press zero clearing “” can set the origin of X,Y axis.







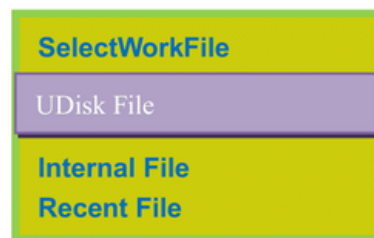

Press zero clearing “” to set the origin of Z axis. It should be noted that if user have already used the tool setting function which combination button is

“”+“”, will no need to press the “” button.

5.4.2 Choose processing files

After determined the workpiece origin, press“” will appears a dialog frame:







Press “”, “” to move the cursor and choose, press “” to enter into the list, the screen will display three file name, choose the file by pressing “”, “”, Press “”, “” to turn to the next page. Press “” to exit.

5.4.3 Processing parameters setting

After choosing the processing file please press “”, enter into processing parameters setting, it includes work speed、travel speed (or Fast speed)、speed scale(speed ratio)、fall down speed(or Z down ratio).

Set Work Param	
WorkSpd	300000
FastSpd	300000
SpdScale	.000
FallDown	0.200

Press “” and “” to move cursor, press “” to set the value (next value setting is the same as this one), then press “” to save, the system will check the processing code and start to process when checking finished.

The system code checking is auto mode, user can press “” to skip the checking and start running file immediately.

System will remember the checking only when the previous checking is a complete and correct checking. So that the system will not check the same code again next time.





In the process of processing, the screen scrolling display real-time processing speed, operation time, current line number. We can switch these options by

pressing “”. —

● 5.5 During processing operations



5.5.1 Speed ratio & spindle grade Adjusting



1) Adjust speed ratio

In process of processing, press “”, “” can directly change speed ratio, current speed= set speed * ratio, each push on “” or “”, the speed ratio will go up or down drop 0.1. Speed ratio: max 1.0, min 0.1, the displayed speed will correspond to the changing of speed ratio, but time will not change.

2) Adjust spindle grade

If user has set multistep speed, the DSP handle can change the multistep speed

in process of processing. Press “” and “” to change spindle grade.

Each push of “” and “” will go up or down drop 1 grade till to S8 or S1.

5.5.2 Pause & adjust position



Press “” pause processing. The right upwards of screen will change from “MAUN” to “PAUZ” and machine paused processing except the rotating of spindle. Shown below:

1X	7.000	PAUS
1Y	8.000	S2
1Z	-2.000	H SP
User will start		

At this moment, the user is allowed to adjust the position of X, Y and Z axis. The system default motion mode is STEP. So that user can fine adjust each axis distance. Machine moves one low or high speed grid distance every step. Meanwhile, user can change the speed mode to high mode just press “”.

When the adjustment is finished, press “” again, screen shows below:

1X	7.200	PAUS
1Y	41.300	S2
1Z	-0.200	H SP
Restore Position		

The system asks the user whether save the modified position. Press “”/ “” the system will start processing in modified position, press “”, system will back to the position before modifying.



5.5.3 Breakpoint processing & power down protection

1) Breakpoint processing



If user presses “” during process of processing, the screen shows below:

Save break
Save break
Discard break

If we want to save breakpoint, press “”, the screen displays break

list (totally 8), press “”, “” to choose the save position and then press “” to save, system auto go to standard interface. If we want to

continue processing from the breakpoint, we can choose the combination

button “” + “1-8”. First press “” and not release it, at the same time press number button(1-8), then release together, the system will start processing from the breakpoint.

For example: You want to start processing from the breakpoint 1, then you

should use the combination button “” + “1”, system will restore processing from breakpoint 1. The screen shows below:

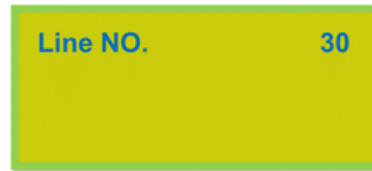

If you want to go backwards from this breakpoint, press “” and input the

line No., and then press “”, system will work from the new line number.

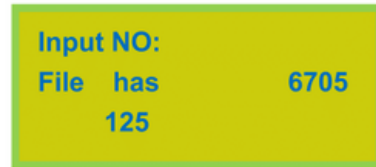

2) Power off protection

When there is a sudden power failure during processing, system will save current coordinate and parameters, while power restart, process continue. Before that, system must have a home motion. Shown as below:

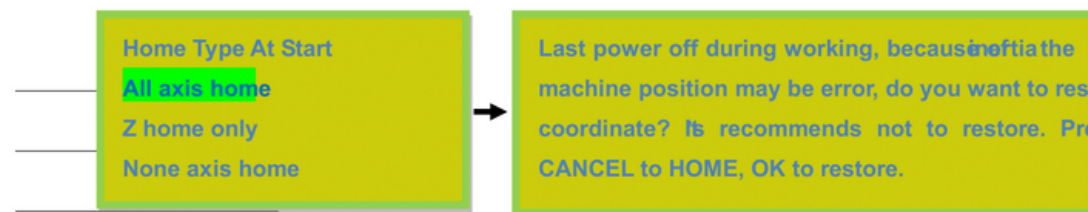

Press “” to continue unfinished processing, it will display stop line No,

and the line number can be chosen. Press “” cancel the power off protection.

● 5.6 Advanced Processing





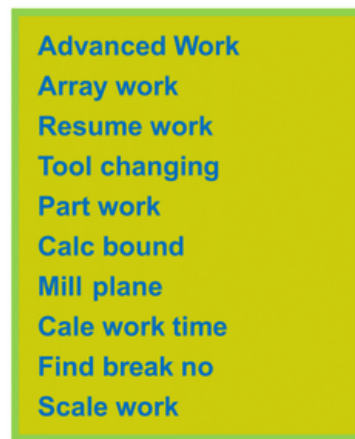



Advanced processing is designed for some special requests, it contains: Array work, Resume work, Tool changing, Part work, Calculate bound, Mill plane, step work file, Calculate work time, Find break NO. The combination button is “”+

“”, shown below:



1. Array work

Steps are as below:

- 1) Press “”, “” to move cursor to the Array work, press “”,
press “” or “” to select different files list.
- 2) Press “” to enter file list, then press “”, “” move the cursor to choose object file.
- 3) Set processing parameters, also can modify the array parameters in this step,



or you can go to “AUTO PRO SETUP”, choose “Work Array” and modify the array parameters. The rest steps are similar to the normal processing. System will start to work according to the user’s setting.



4) In the processing of array work, you can view current row number, volume

number etc. by pressing “”.

2. Resume work

Steps are as follows:

Press “”, “” to move cursor to resume work, press “” to

enter, then press “” or “” to select different break points, and

then press “”, system will restore processing from the break point. If

you want to go backwards from this breakpoint, press “” and input the

line No., and then press “”, system will work from the new line number.



3. Tool changing

It achieve manually change the tools at the position you set. Press “” to



enter into the setup, and also press “” back to work origin.

4. Part work

Part work means user can select start line and stop line, so part of the processing file can be processed. The steps are as follows:

1) Press “” to set, press “” and “” to move the cursor to

select different file list;

- 2) Press “” to enter, press “” and “” to select a file, then

press “”, system start to read the file.

- 3) After read the file, press “” the screen display line 1 of the code, press



“”, prompted “input start number: displays total lines”, input number

of start line and press “” to confirm, if input wrong number, just press

“” to delete it.

- 4) Press “” again, to set the end line, the screen displays “input end

number”, press “” the screen save the changed start line number, press



“”, Input end line in cursor, press “” to confirm,



press “” to modify.

- 5) Set processing parameters.

5. Calculate bound

Calculate bound means user can check the size of processing, So as to avoid unnecessary waste of materials and processing errors. The steps are as below:

- 1) Press “” to enter, then press “” or “” to select file list;

- 2) Press “” get into the file list, and then press “” or “” to

choose file.



- 3) Press “”, system start to read the file, after reading the file, the system will calculate the area.

6. Mill plane



Include two types: scan mill and encircle mill.

Steps are as follows:

1. Scan mill

Scan mill set	
Scan type	X Scan
Width	100.000
Height	100.000
Diameter	10.000
Depth	0.100
Z Step	0.100
T Ratio	0.800





- 1) Press “” or “” to move cursr to choose the mill type.



- 2) Press “” to enter the scan mill set, it includes: Scan type, Width, Height, Diameter, Depth, Z Step, T Ratio.



- 3) Press “” and “” to move cursor on the option which need



modify, press “” to choose mill type(X Scan or Y Scan), also press









this button to modify the parameters. Press “” after modified all the parameters to save them.

2. Encircle mill



Scan mill set	
Scan Type	AC
Width	100.000
Height	100.000
Diameter	10.000
Depth	0.100
Z Step	0.100
T Ratio	0.800

- 1) Press “” or “” to move cursor to choose the mill type.
- 2) Press “” to enter the scan mill set, it includes: Scan type, Width, Height, Diameter, Depth, Z Step, T Ratio.
- 3) Press “” and “” to move cursor on the option which need modify, press “” to choose mill type(AC or C), also press this button to modify the parameters. Press “” after modified all the parameters to save them.

7. Calculate work time



Calculate the processing time according to the system processing speed. After pre-read processing file, the system will display total processing time. Different processing speed will correspond to different processing time.

8. Find break no

Look for position line number. If accidentally cutter break and user hasn't saved the break point, reboot system and replace the cutter. After that, user can manually move X, Y axis to the nearest point where the cutter was broken (recommend to move

a little further), press “” enter into “Find break no.”, afterwards choose the previous processing file, the system will prompt “searching current position”. System

will start processing after finished the searching, the system will prompt “press

“”start processing, press “” to view the current position of line number”.

9. Scale work

If the actual processing requires different sizes of the same file, you can select the **scale work**, you need to enter an enlargement or reduction ratio for processing.

Step Press “” to get in “Scale work”

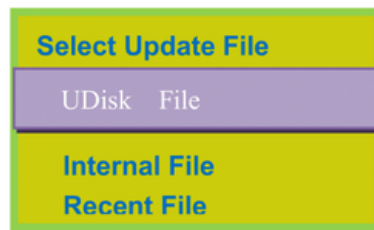

Choose Processing file, input correct parameters:



Scale	work	param
X	scale	1.000
Y	scale	1.000
Z	scale	1.000



and then press “” to start processing.

● PS1. System upgrade

Copy upgrade file to U disk, and insert U disk into handle, file format: extension *******.PKG** & shown as **rz-xxxx**.

U Disk Upgrad Method 1

1.1 Press “”, and then select “System Setup”, press “” to enter,

press “” / “”, select “Auto Upgrade”. The screen display:

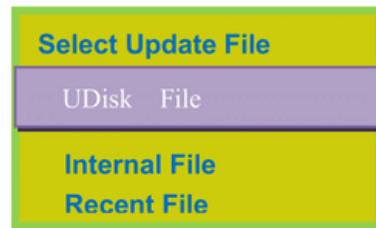

1.2 Press “” to enter, select “Udisk File”, then select upgrade file, press

“”, system will auto upgrade.

1.3 After upgrade completed, restart the handle.

U Disk Upgrade Method 2

2.1 Copy upgrade file to U disk, and insert U disk into handle.

2.2 Press “” + “”, screen display:

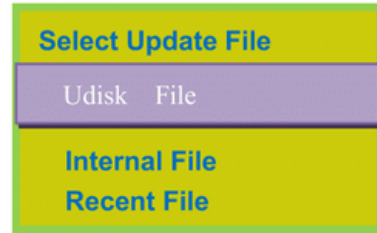



2.3 Repeat Method 2 operation 1.2&1.3.

● PS2. Operations offHandle communicating with computer

Users can copy file from computer to handle after “**Product ID:A010XXXX & Update Version rz-1967**” version. Connect handle and computer by USB cable, users can find portable storage device on the computer, and then copy processing files from computer to handle inner. This function can insure that if USB port of the handle is broken or there is no U disk, the machine can still work normally.

Operation step

1. Press any two buttons at the same time (for example: “” + “”).
2. Connect handle and computer by USB cable, it means that the handle is powered by computer, loosen the buttons after the power supply.
3. Handle screen display:



Connect successfully.

4. Open “My Computer”, and you will find portable storage device,

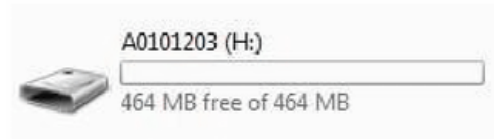

A0101203(H:) :Handle, Users can copy processing files to handle inner.

5. Connect handle and machine, Choose internal file to start processing.

NOTE: Users can check hardware type in Version View: “FlashDiskMode” is necessary,if not, users can not copy processing files from computer to handle inner.

● PS3. Common problems and troubleshooting

Solutions of the faults display on the screen

1. Indefinite screen flicker or automatically restart
Analyses and solutions:
 - 1、 Power supply is insufficient. Check power supply if there are problems, and change high-quality power supply to solve the problems.
 - 2、 The local power grid unstable. Check local grid voltage instability,or increase the the regulator filter device.
 - 3、 There are something wrong with the power chip of the handle. This phenomenon also appears when the handle is powered through the USB cable to the computer,please return back the handle to our company.
2. Can not set working origin
Analyses and solutions:
 - 1、 You may get into the mechanical coordinate system. Press the button "menu" + "1" to back to the first work coordinate system.
 - 2、 The buttons are broken.menu-system setup- buttons check, to check the buttons are normal or not.

Faultsin practical operation

1. The file size does not match the size of the actual set

Analysises and solutions:

- 1、 Pulse equivalent is wrong.
- 2、 You does not select the right tool.
2. The screen displays "beyond limit" when processing file

Analysises and solutions:

- 1、 The machine is not carried back to zero, the system is not able to confirm the actual position. Make the machine back zero.
- 2、 After setting the working origin, the reserved range is less than the actual file size .Determine the actual file size and set correct working origin.
- 3、 You set the wrong working origin in the file. Check the path of the file, and re-export the correct file.
3. Z axis (spindle) fall down abnormally (too fast) during processing

Analysises and solutions:

- 1、 Working speed beyond the fastest speed of Z axis. " Machine setup " - " Max speed limit ", set the speed to the safe speed.
- 2、 Coupling is loosing or transmission slippages. Re-adjustment the connecting parts.
- 3、 The lines connect the interface board with the motor drivers has disruption. Re-adjust the lines.
- 4、 Processing file error. Check processing file, try to download the correct processing file to U disk or handle internal.
- 5、 There is something wrong with the lines connectting Z axis motor and motor driver. Replace the lines.
4. Each time repeating the same processing file after backing to the machine origin , Z axis depth is not the same

Analysises and solutions:

- 1、 Machining countertop is uneven or processing object not firmly fixed, re-milling countertop adjust the flatness.
- 2、 Z-axis origin detection switch repeat positioning accuracy error, causing each Z axis homing error. Replace a high-quality detection switch.
- 3、 Too much interference in the Z-axis homing process to form a false origin. Re-adjust the line.
5. Back to the origin , the machine can not stop

Analyses and solutions:

Double press on the "menu" button, input signal (origin detection switch signal) self-testing, whether the detection signal is triggered or connect normally.

- 1、 The the origin detection switch is damaged. Replace a new one.
 - 2、 The distance of the origin detection switch detection sheet beyond the detection range of the switch, adjust the position of the test piece.
 - 3、 The origin detection switch to the interface board wiring aging or loosening. Again check the connections.
 - 4、 The interface board is broken. Depot Repair.
 - 5、 50-pin data cable is broken. Replace it with a new data line.
6. Back to the machine origin , machinemove to the reverse direction

Analyses and solutions:

- 1、 The origin detection switch types do not match with the definition of the corresponding level. Modify the level. (Normally open type corresponds to a level defined the direction of the arrow down, normally closed type corresponds to the level defined arrow up).
 - 2、 The origin detection switch is damaged. replace a new one.
 - 3、 The origin detection switch connects interface board not well. Refresh the line to determine the wiring is correct.
 - 4、 Too much interference, resulting in the illusion of the detection switch has been triggered. Recalibrated the whole circuit.
 - 5、 The interface board is broken. Depot Repair.
 - 6、 50-pin data cable is broken. Replace the data line.
7. Abnormally working when processing file or the actual file is different from theoretical file

Analyses and solutions:

- 1、 The program disorder.
- 2、 External interference is too large.Refresh connection. (separate strong

electirc from weak current, "GND" of inverter separated from the other components).

8. Start automatic tool setting, the tool does not stop after touching feeler bolock

Analysises and solutions:

- 1、 "cutter" signal line connects "cutter" terminal not well.
- 2、 The "GND" terminal of interface board does not connect with spindle shell or connect not well.

9. Handle LCD digital changes, the machine does not move

Analysises and solutions:

If one axis is not moving, it may be a connection problem. Change another normal terminal to this terminal, if it is ok, the motor driver is ok. Maybe there is something wrong with interface board, 50-pin cable. If it is still not moving, it is necessary to detect the corresponding drive and motor.

If all axes are not moving, firstly check if there are problems in the 50-pin cable and interface, secondly check the power supply of the motor drivers. Lastly, you have to check the mechanical part .

10. It is normal to the move from one location to another location, but when return from that position to the original position is not normal

Analysises and solutions:

Mechanical problems, screw may install not well.

Electrical components and wiring problem

1. an axis or multi-axis only one-way movement after handle power-on

Analysises and solutions:

- 1、 There is something wrong with the lines connect the interface board with the motor driver, check the connection.
- 2、 Interface board is damaged. Replace the interface board.
- 3、 The motor driver is damaged. Replace the driver.

2. The certain axis motor does not move after handle power-on
Analysises and solutions:
 - 1、 Operator makes pulse line and direction line oppositely, rewiring it.
 - 2、 5V common anode end of the motor driver disconnected, check the connection.
 - 3、 The motor driver is damaged, operator can promote motor after handle power-on.
 - 4、 The chip of the interface board damages, no pulse signal output.
3. Screen is not bright after handle power-on, and connected handle to computer with a USB cable the screen displays normal
Analysises and solutions:
 - 1、 The handle does not connect to power supply. Check DC24V power supply output normal or not, if normal please check the cable from the power supply to the interface board.
 - 2、 The 50-pin cable is damaged or the interface is broken.
4. Screen is not bright after handle power-on, and connect the handle to computer by USB cable,the screen is also not bright
Analysises and solutions:
 - 1、 This phenomenon may due to the handle shocked by external force or fall on the ground, causing the crystal processor damaged. Depot Repair.
 - 2、 Users connect high voltage power supply, Depot Repair.
5. The screen display “spindle on”, actually the spindle off, the screen display “spindle off”, actually the spindle on
Analysises and solutions:
 - 1、 There is something wrong with wires. organize your wires.
 - 2、 The output level definition is wrong. Modification correct output level definition.
6. Screen is not bright after handle power-on
Analysises and solutions:

- 1、 The power supply voltage is too big or the chip is broken because operator makes positive and negative of the power oppositely. Depot Repair.
- 2、 The power supply is damaged. Replace the power supply.
- 3、 50-pin data cable damaged. Replace the data line.
- 4、 Handle 50-pin interface damage. Depot Repair.