



PRA DO

AUTOMAÇÃO INDUSTRIAL

Engraving machine motion control system

A18-Four axis mechanical carving

User's manual

ADD.: Beijing haidian district shangdi three street jiahua building A308. P.C.: 100085.

Dell: 010-62970368 82923063. Fax: 82920078

Thank you for choosing the products!

This manual helps you be familiar with the company's products, and get information about systems' components、 configuration,etc.

This manual detailed knowledge of the system characteristics、 operational processes、 installation and commissioning, and safety precautions,please read this manual carefully before using the system and machine, which will help you make use it better.

Cautions:

1. Use of this product is strictly prohibited in the strong interference、 strong magnetic field environment. Operating ambient temperature 0-70 ℃, working environment humidity 0-90% (non-condensing).
2. Insert U disk in the correct direction.Do not pull out 50-pin cable when system run.
- 3.Perform processing U disk file process, do not pull out the U disk to prevent the interruption of data transmission.
4. Strictly prohibited metal, dust, and other conductive substances get into the controller.
- 5.The machine shell should connect the ground wire to ensure the safety of the work and to prevent interference.
6. Prohibited unauthorized disassembly, no internal user repairable parts.
- 7.For long periods of time, please pay attention to the power outage, and retain.
8. Pay attention to water, dust, fire when using it.

9. Do not use the corrosive chemical solvents to clean the equipment.
10. Spindle motor bearing life and its speed is inversely proportional.
11. Graver is very sharp. Do not touch when it is running, in order to avoid injury; Do not use handkerchiefs, scarves contact it to prevent embroiled damage.

Important Notice:

The Company shall not be responsible for any loss caused by improper using or breaking the correct operating procedures.

Beijing ruizhitianhong S&T co.,Ltd owns this manual final interpretation,the company reserves the right to modify all information in this manual, including data, technical details, etc..

CONTENT

Foreword	3
1. RichAuto system composition	4
1.1 System composition	4
1.2 Description of Each Component	5
2. Instruction to Handle controller keyboard	8
2.1 Introduction	8
2.2 Usage	8
2.3 Detail information for key functions	11
3. Wiring Instructions	13
3.1 RichAuto Stepping wiring instructions	13
3.2 Patch Board I / O Description	14
3.3 Hardware Connection.....	19
3.4 Commissioning of The Machine and Control System.....	27
4. Menu direction	27
4.1 Menu category	27
4.2 Menu detail	27
5. Machine operation.....	44
5.1 Return home	44
5.2 Import processing files	44
5.3 Manual processing operation	45
5.4 Automatic machining operation	48
5.5 Processing operations	51
5.6 Advanced Processing	54
PS 1. System automatically update.....	61
PS 2. Common troubleshooting	62

● Foreword

System Introduction:

RichAuto is CNC motion control system independently developed by Beijing ruizhi tianhong and it can be widely applied to machinery, advertisement, woodworking, mold engraving machine, laser, flame, plasma cutting machine, and so on in the machine control field.

RichAuto make DSP as the core control system, High-speed processing operation is the microcontroller, PLC systems can't match; Use embedded structure, High degree of integration, Strong stability, easy to installation and operation; U disk support, Removable storage card reader, With USB Interface, High speed transfer, Plug and play the full realization of all work offline.

Characteristics:

1. System deploy standard X, Y, Z,A/C axis motion control method.
2. Multi I / O Point Control, there is eight input and output signals in every basic I / O signal node. Expansion I / O nodes can be expanded to 32 input and output signals.
3. Support the standard G code, PLT format instructions; support domestic and international mainstream CAM software, such as: Type3, Art cam, UG, Pro / E, Master CAM, Cimatron, Wentai etc.
4. Provide with power-down protection. Instantaneous power processing system to automatically save the current processing of information (file name, current line number processing, processing speed, spindle threshold), when power again machine moves back, the system automatically prompts the user to restore the processing before power down, the processing operations become more humanity.
5. Support breakpoint memory, file selection, processing. Save 8 different breakpoint processing information.

ADD.: Beijing haidian district shangdi three street jiahua building A308. P.C.: 100085.

Dell: 010-62970368 82923063. Fax: 82920078

6. Multi-coordinate memory function. Provide nine working coordinate system, the user can switch among the 9 coordinate, each coordinate system can save a process origin information.
7. Support online adjust spindle operating frequency. The spindle frequency from 0 to maximum frequency is divided into 8 thresholds; 1 - 8 threshold can be processed directly adjust up and down without suspend processing.
8. Support adjust speed ratio online. Users can adjust the speed ratio, to adjust the processing speed and empty running speed, speed ratio values from 0.1-1, Ascending or descending per 0.1 numerical.
9. Simply manual operate mode. In manual mode, the system provides three kinds of sports concluding continuous, step (crawl), distance, manual operation became more simple and convenient.
10. Identifies M code, F code and other development commands, can open a special code based on user needs.
11. Built-in 512 M memory.
12. Unique handheld form factor with one hand to hold. Own liquid crystal display and 16 key keyboard , operate intuitive and flexible, no longer dependent on the computer, the full realization of full offline operation
13. Comes with USB communications port, file transfer efficiency can be directly read U disk, card reader file, Plug and Play.
14. Self-test function, the system comes with I / O port signal detection capabilities, ease of remote maintenance.
15. Processing with high-speed and smooth, support high subdivide, make sure processing with high accuracy and high speed.
16. Unique in Chinese-English to show double-interface, can be realized in switching Chinese and English show online.

ADD.: Beijing haidian district shangdi three street jiahua building A308. P.C.: 100085.

Dell: 010-62970368 82923063. Fax: 82920078

17. Multi-language display. Support for Simplified Chinese, Traditional Chinese, English, Russian, French and other languages, can be customized according to user needs.
18. System can support automatic dynamic upgrades, convenient to remote operation, remote maintenance.

1. RichAuto system composition

1.1 System composition

RichAuto control system contains the following parts: A hand-held motion controller ,a line adapter board, a fifty pin data transmission cable, an USB communication cable.

RichAuto accessories schematic diagram



Hand- held motion controller



Interface board



50-pin data transmission cable



USB communication cable

Figure 1-1

ADD.: Beijing haidian district shangdi three street jiahua building A308. P.C.: 100085.

Dell: 010-62970368 82923063. Fax: 82920078

1.2 Description of Each Component

1. Handle: the core of the lower computer, it contains six modules.



- (1).LCD: Resolution of 128 * 64 LCD display, To display the machine motion, and the information, such as the system settings and other information.
- (2).Key Board: It contains 16 keys to input the system parameter information and operate the machine.
- (3). U Disk Interface: external memory access ports to U disk and the memory card. The file format can be identified by the external memory is FAT16/32.
- (4).50-pin Data Cable Jack: through 50 pin data transmission cable and line adapter can achieve the connection between system and the machine. The system sent the movement to machine motion actuator.

ADD.: Beijing haidian district shangdi three street jiahua building A308. P.C.: 100085.

Dell: 010-62970368 82923063. Fax: 82920078

(5).Company LOGO.

(6).USB Communication Port: USB data line access port. It is used to connect the host computer with r computer.

2. Interface Board: The operation between the low computer and machine is completed by the link of the interface boards. It contains 6 parts.

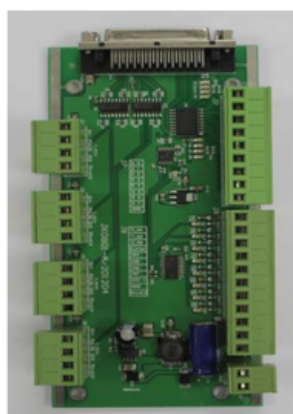

Interface board

(1). 50-pin data cable jack: The connection between the system and the machine can be completed through 50 pin data transmission cable and line adapter and then the system can sent the movement signal to machine motion actuator.

(2). Output control terminal: It can control start and stop of the spindle and gear change. Different connection ways refer to different control. You can check the details in the menu notes, "spindle set the option" Help.

(3). Input control terminal: The input terminal for the machine origin detection switch signal.

ADD.: Beijing haidian district shangdi three street jiahua building A308. P.C.: 100085.

Dell: 010-62970368 82923063. Fax: 82920078

(4).Power supply terminal: the input terminal for system switching Power Supply. (DC24V 3A)

(5).Motor drive control terminal: the output terminal for drive control line.

3. 50 pin data transmission cable



4. USB communication cable



2 Instruction to Handle controller keyboard

2.1 Introduction:

RichAuto system handle controller defines 16 operation keys according to the system functional requirements. Each key has one or more functions under different work status;

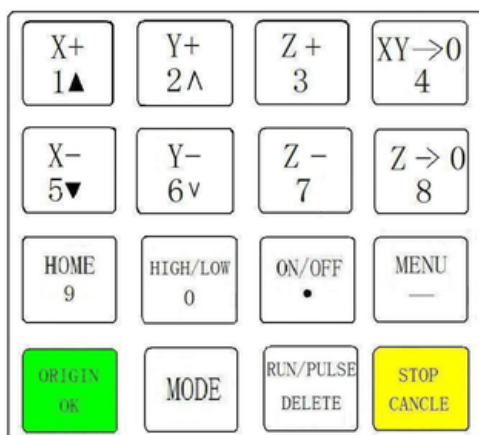

16-key layout

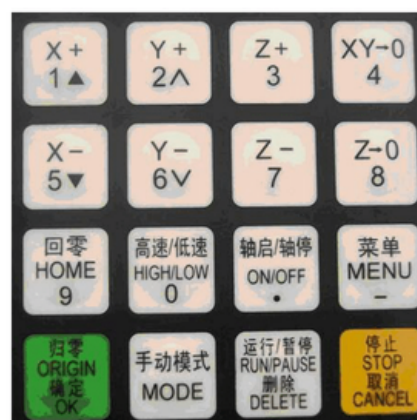

Chinese Button really making plans

2.2 Usage:

RichAuto control system divided the key's operation into one-touch button operation, and the combined-key operation.

One Touch: Press one button on handheld motion controller.







ADD.: Beijing haidian district shangdi three street jiahua building A308. P.C.: 100085.

Dell: 010-62970368 82923063. Fax: 82920078

Combined-key operation: Press two buttons at the same time to achieve the operation;



The operation step: press one main function key and meanwhile press a second accessibility key, and then release the two keys at the same time to realize the combined-key operation.

PS: Commonly used combined-key list:





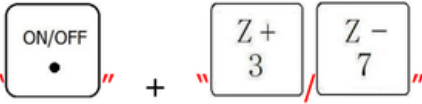
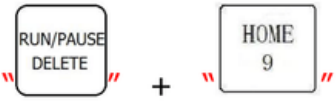
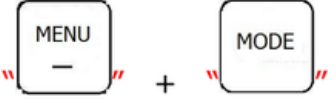
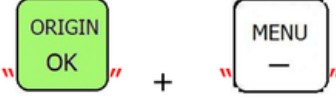
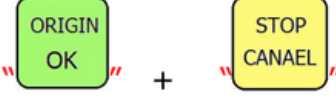

	Combined-key	Function
1	 + "0-9" Number keys	to switch the coordinate system (0 for the mechanical coordinate system , 1 - 9 for the work coordinate system)
2	 + 	Start Z-axis automatic tool setting
3	 + "1-8" Number keys	to start the break processing (support number 1 - 8)
4	 + 	to start the advanced processing modes

ADD.: Beijing haidian district shangdi three street jiahua building A308. P.C.: 100085.

Dell: 010-62970368 82923063. Fax: 82920078









5		To switch gear shaft
6		Repeat last time processing
7		Operate machine by entering coordinates parameters
8		System update
9		Quit buttons check
10		Working origin of X axis and Y axis setting
11		Z axis origin setting

2.3 Detail information for key functions:

key	Function
	Positive movement of X axis, Menu upward , figure 1 inputting
	Positive movement of Y axis, accelerate process speed, figure 2 inputting
	Positive movement of Z axis, figure 3 inputting, rise spindle speed in process
	A/C axis forward rotation, figure 4 inputting
	Negative movement of X axis; Menu downward, figure 5 inputting
	Negative movement of Y axis; slowdown process speed; figure 6 inputting
	Negative movement of Z axis, figure 7 inputting, spindle speed adjusting in process

ADD.: Beijing haidian district shangdi three street jiahua building A308. P.C.: 100085.

Dell: 010-62970368 82923063. Fax: 82920078

	A/C axis reversing rotation ; figure 8 inputting
	Axes home to machine tool origin, figure 9 inputting
	Manual moving mode, high speed or low speed selection, figure 0 inputting, change work coordinate & mechanical coordinate when auto work
	Spindle startup/stop, decimal point inputting
	Menu setting entering, negative symbol inputting, multi process state checking
	All axes go working origin: confirm of motions /inputting/operating
	Manual move, continue, step and distance modes selection
	Cut process running/pause/inputted words delete/ different property selecting in Menu

ADD.: Beijing haidian district shangdi three street jiahua building A308. P.C.: 100085.

Dell: 010-62970368 82923063. Fax: 82920078

	High/low speed parameter adjust, Cut process stop/selections, inputting and operating cancel
---	--

3. Wiring Instructions

3.1 RichAuto Stepping wiring instructions

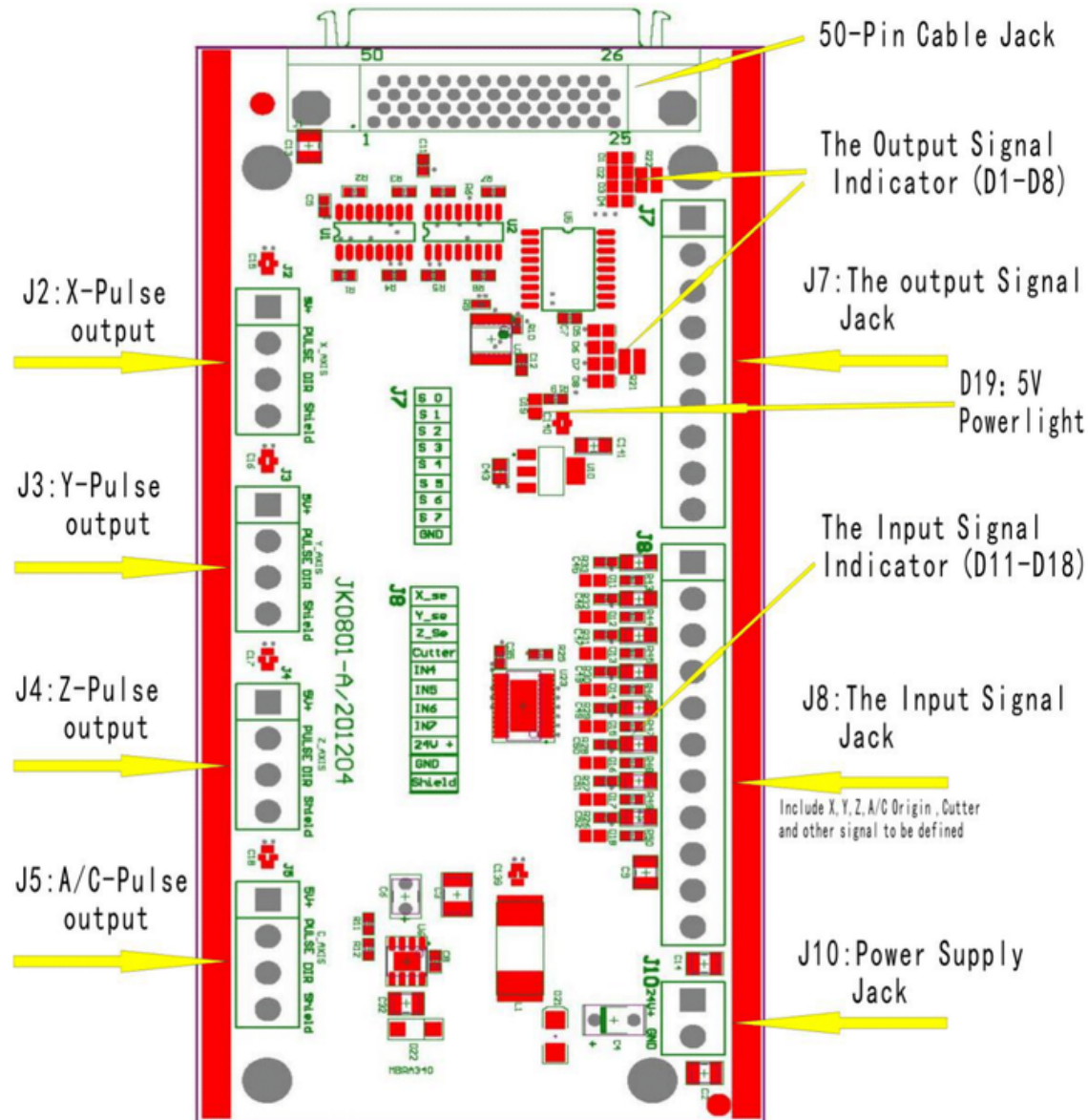

ADD.: Beijing haidian district shangdi three street jiahua building A308. P.C.: 100085.

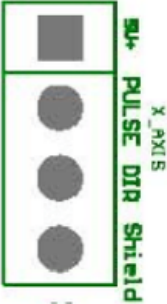
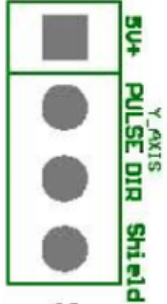

Dell: 010-62970368 82923063. Fax: 82920078

3.2 Patch Board I / O Description

Port label	Port definition	Pin Definition	Pin functions and parameters	Notes
J10 	System Main power	System main power supply side	System main power supply terminal , interface board give DC 5V for system. When F3 shorted can provide voltage to XYZ	Power area: DC10V~DC24V/3A~40V
J 2 	X-axis pulse output port	Were positive signal output port	X-axis drive common anode power supply terminal 5V output	Do not impose voltage on this pin
		Pulse signal output port	X-axis drive pulse signal output port, the output voltage $\geq 3V$ drive current $\leq 8mA$	
		direction signal output port	X-axis direction of the drive signal output port output voltage $\geq 3V$ drive current $\leq 8mA$	
		Shield connection port	X-axis drive signal output voltage line terminal shield	Do not use this port for the grounding port
J 3 	Y-axis pulse output port	Were positive signal output port	Y-axis drive common anode power supply terminal 5V output	Do not impose voltage on this pin
		Pulse signal output port	Y-axis drive pulse signal output port, the output voltage $\geq 3V$ drive current $\leq 8mA$	
		direction signal output port	Y-axis direction of the drive signal output port output voltage $\geq 3V$ drive current $\leq 8mA$	
		Shield connection port	Y-axis drive signal output voltage line terminal shield	Do not use this port for the grounding port

ADD.: Beijing haidian district shangdi three street jiahua building A308. P.C.: 100085.

Dell: 010-62970368 82923063. Fax: 82920078

Port label	Port definition	Pin Definition	Pin functions and parameters	Notes
J 4 	Z-axis pulse output port	Were positive signal output port	Z-axis drive common anode power supply terminal 5V output	Do not impose voltage on this pin
		Pulse signal output port	Z-axis drive pulse signal output port, the output voltage $\geq 3V$ drive current $\leq 8mA$	
		direction signal output port	Z-axis direction of the drive signal output port output voltage $\geq 3V$ drive current $\leq 8mA$	
		Shield connection port	Z-axis drive signal output voltage line terminal shield	Do not use this port for the grounding port
J 5 	C-axis pulse output port	Were positive signal output port	C-axis drive common anode power supply terminal 5V output	Do not impose voltage on this pin
		Pulse signal output port	C-axis drive pulse signal output port, the output voltage $\geq 3V$ drive current $\leq 8mA$	
		direction signal output port	C-axis direction of the drive signal output port output voltage $\geq 3V$ drive current $\leq 8mA$	
		Shield connection port	C-axis drive signal output voltage line terminal shield	Do not use this port for the grounding port

ADD.: Beijing haidian district shangdi three street jiahua building A308. P.C.: 100085.

Dell: 010-62970368 82923063. Fax: 82920078

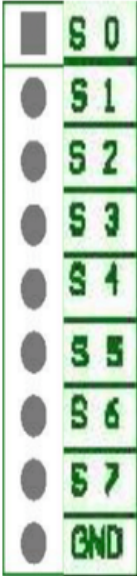
Port label	Port definition	Pin Definition	Pin functions and parameters	Notes
J 7 	Output Control terminal	Y1(S0): Spindle ON/OFF	Connect to FWD of inverter	Output Low level signal
		Y2(S1): speed 1	Connect to inverter to control speed	Output Low level signal
		Y3(S2): speed 2	Connect to inverter to control speed	Output Low level signal
		Y4(S3): speed 3	Connect to inverter to control speed	Output Low level signal
		Y5(S4): Alarm LED	Ligt when there is something wrong with system	Output Low level signal
		Y6(S5): Work LED	Ligt when system works	Output Low level signal
		Y7(S6): definable	user-defined signal	Output Low level signal
		Y8(S7): definable	user-defined signal	Output Low level signal
		GND:output GND		GND connect to this terminal in control inverter speed mode

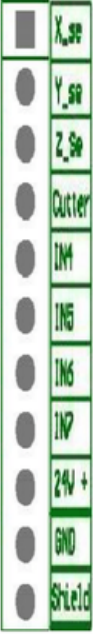

ADD.: Beijing haidian district shangdi three street jiahua building A308. P.C.: 100085.

Dell: 010-62970368 82923063. Fax: 82920078

Port label	Port definition	Pin Definition	Pin functions and parameters	Notes
J 8 	input Control terminal	X1:X _{se} : X origin sensor signal input	X origin sensor signal input terminal	Input low level signals
		X2:Y _{se} : Y origin sensor signal input	Y origin sensor signal input terminal	Input low level signals
		X3:Z _{se} : Z origin sensor signal input	Z origin sensor signal input terminal	Input low level signals
		X4: A/C origin sensor signal input	A/C origin sensor signal input terminal	Input low level signals
		X5:Tool-setting sensor signal input	Tool-setting sensor signal input terminal	Input low level signals
		X6: Definable signal	Definable signal input terminal	Input low level signals
		X7: Definable signal	Definable signal input terminal	Input low level signals
		X8: Definable signal	Definable signal input terminal	Input low level signals
		24V+: Sensor power input	X、Y、Z sensor isolate circuit power supply positive input terminal	Sensor isolate circuit supply voltage range DC10V~DC24V
		GND: GDN input	X、Y、Z sensor isolate circuit power supply negative input terminal	
		Shield: Shield input	Sensor signal cable shield input terminal	Do not use this port as a negative use of the sensor isolation circuit power

ADD.: Beijing haidian district shangdi three street jiahua building A308. P.C.: 100085.

Dell: 010-62970368 82923063. Fax: 82920078

Port label	Port definition	Pin Definition	Pin functions and parameters	Notes
	D19	Power LED	Interface board 5V indicator indicate the interface and internal power supply status moderators	Lights after power
	D11	Status indicator	X origin status indicator	Light after power. Input low level signal, the lights will be put out. Release the signal, the lights will be bright again
	D12	Status indicator	Y origin status indicator	
	D13	Status indicator	Z origin status indicator	
	D14	Status indicator	A/C origin status indicator	
	D15	Status indicator	Tool-setting Status indicator	
	D16	Status indicator	Definable signal status indicator	
	D17	Status indicator	Definable signal status indicator	
	D18	Status indicator	Definable signal status indicator	
	D1	Status indicator	output terminal Y1 status indicator	Output low level signal when the system works
	D2	Status indicator	output terminal Y2 status indicator	
	D3	Status indicator	output terminal Y3 status indicator	
	D4	Status indicator	output terminal Y4 status indicator	
	D5	Status indicator	output terminal Y5 status indicator	
	D6	Status indicator	output terminal Y6 status indicator	
	D7	Status indicator	output terminal Y7 status indicator	
	D8	Status indicator	output terminal Y8 status indicator	

ADD.: Beijing haidian district shangdi three street jiahua building A308. P.C.: 100085.

Dell: 010-62970368 82923063. Fax: 82920078

PS: All the pin terminals are for the parties sort the mouth as the first one, the bit serial extended direction of the arrow.

3.3 Hardware Connection

Installation Requirements: Switching Power (24V 3A) should add a filter to prevent interference with the electric field. If origin detecting switch are different power supply type, the special testing switching power is needed. (24V origin detecting switch is the best choice)

RichAuto control system realizes its control through the connection between the interface board and CNC machine. Interface board terminal can be divided into input terminal and output terminal :

Input terminal includes:

J8 (input control terminals)

J10 (main power terminals) .

Output terminal includes:

J2 (X axis pulse signal output terminal)

J3 (Y axis pulse signal output terminal)

J4 (Z axis pulse signal output terminal)

J5 (A/C axis pulse signal output terminal)

J7 (output control terminal)

ADD.: Beijing haidian district shangdi three street jiahua building A308. P.C.: 100085.

Dell: 010-62970368 82923063. Fax: 82920078

Input terminal

1 sensor input ①Mechanical: Ordinary axis (Y,Z are the same as X)

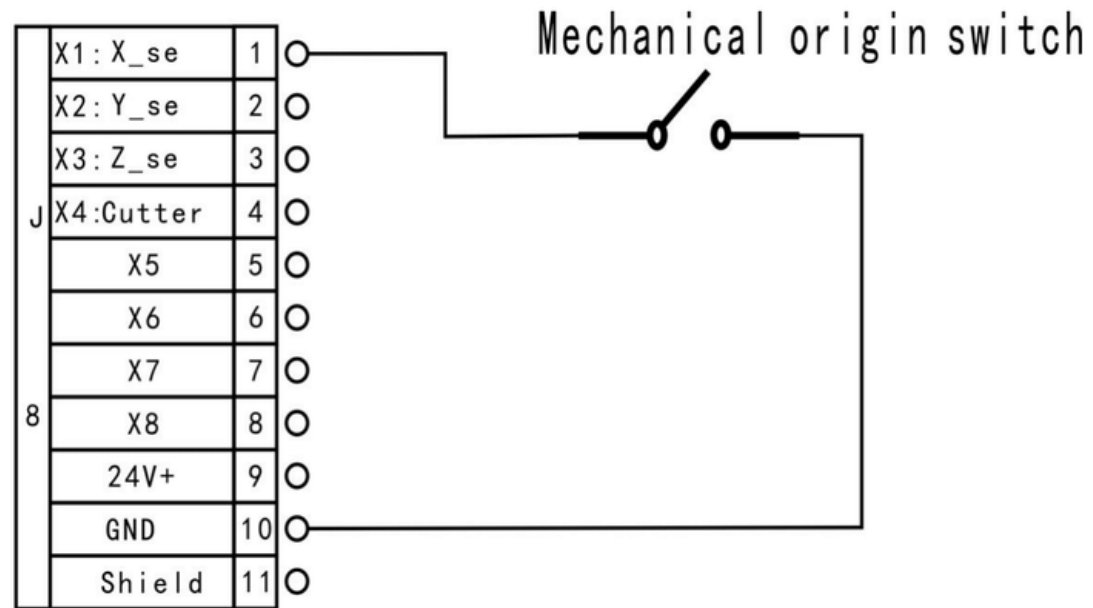

Rotation axis:

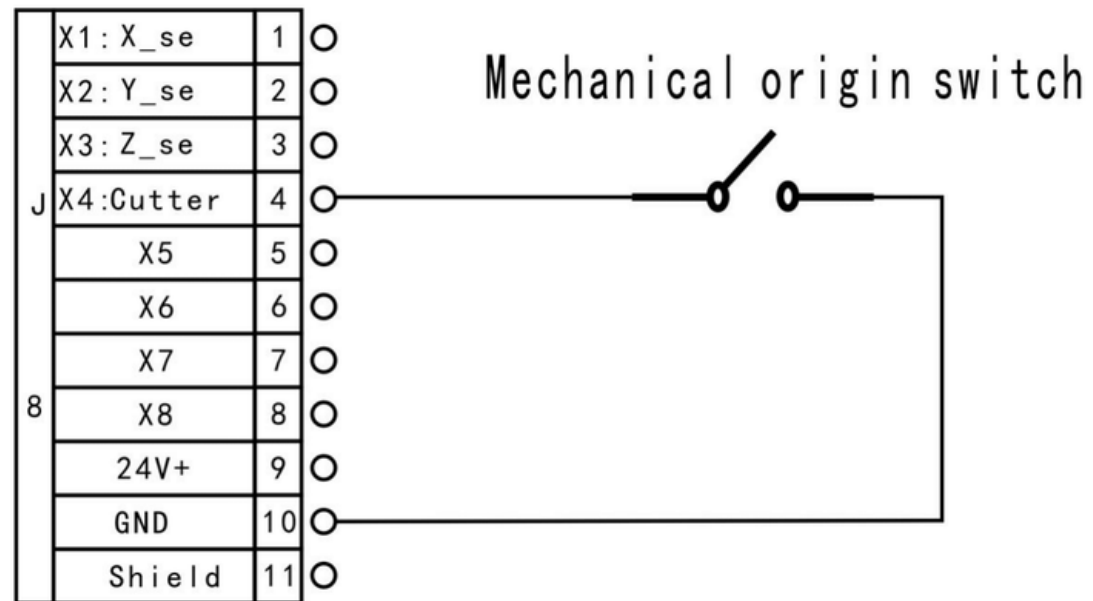

ADD.: Beijing haidian district shangdi three street jiahua building A308. P.C.: 100085.

Dell: 010-62970368 82923063. Fax: 82920078

② NPN(NO): Ordinary axis (Y,Z are the same as X)

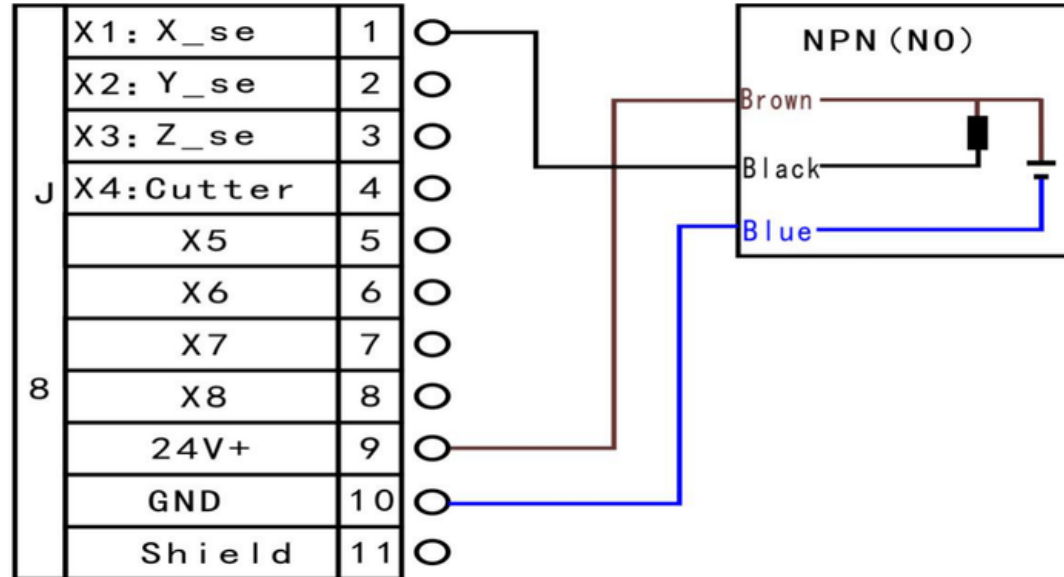

Rotation axis:

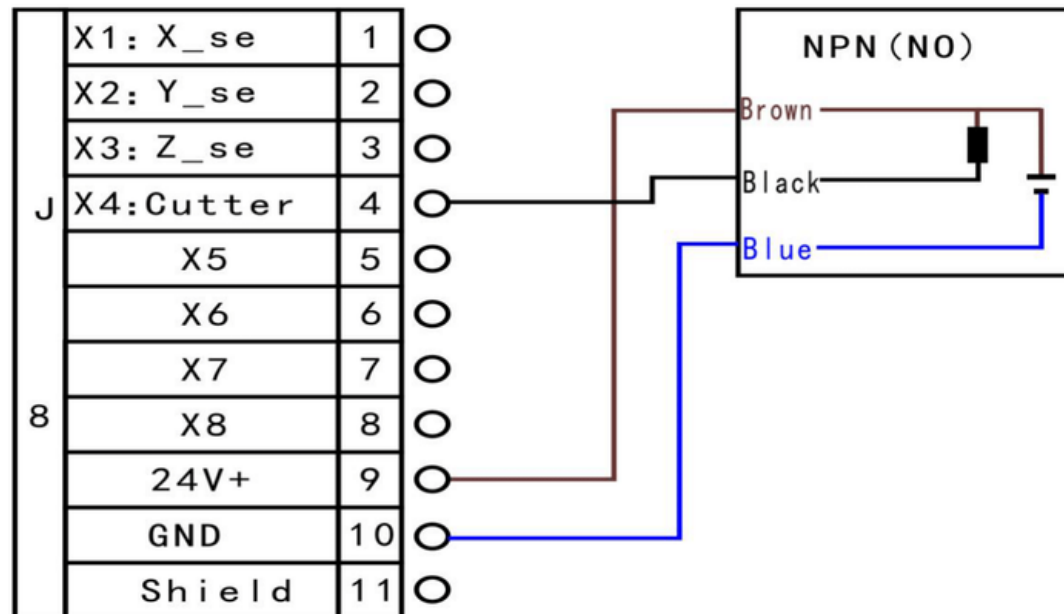

③ PNP(NO) : Ordinary axis (X and Z are the same as Y)

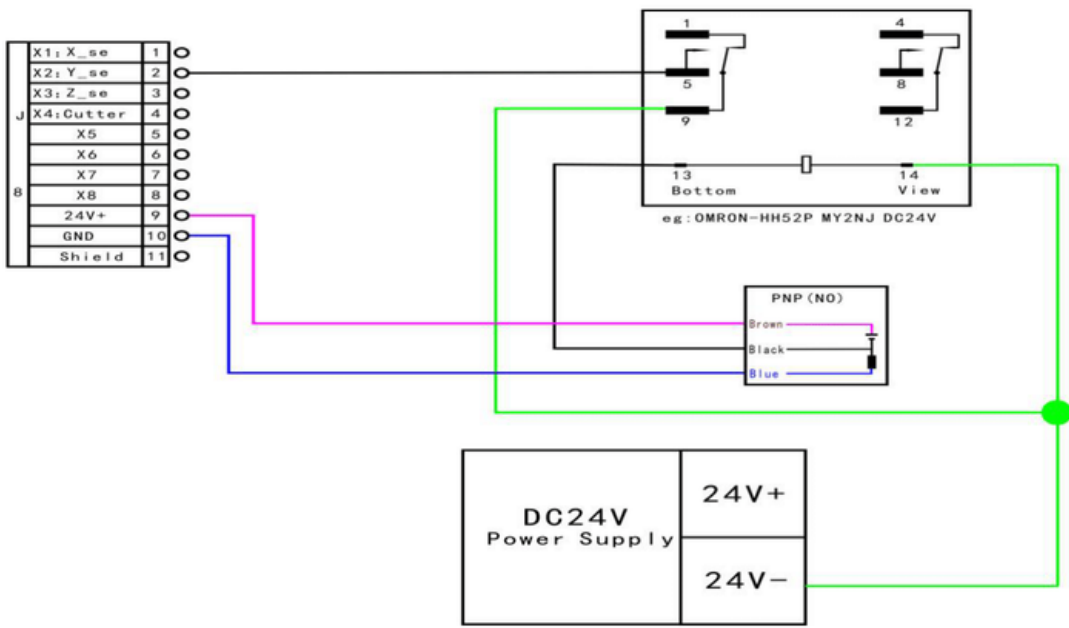

Rotation axis:

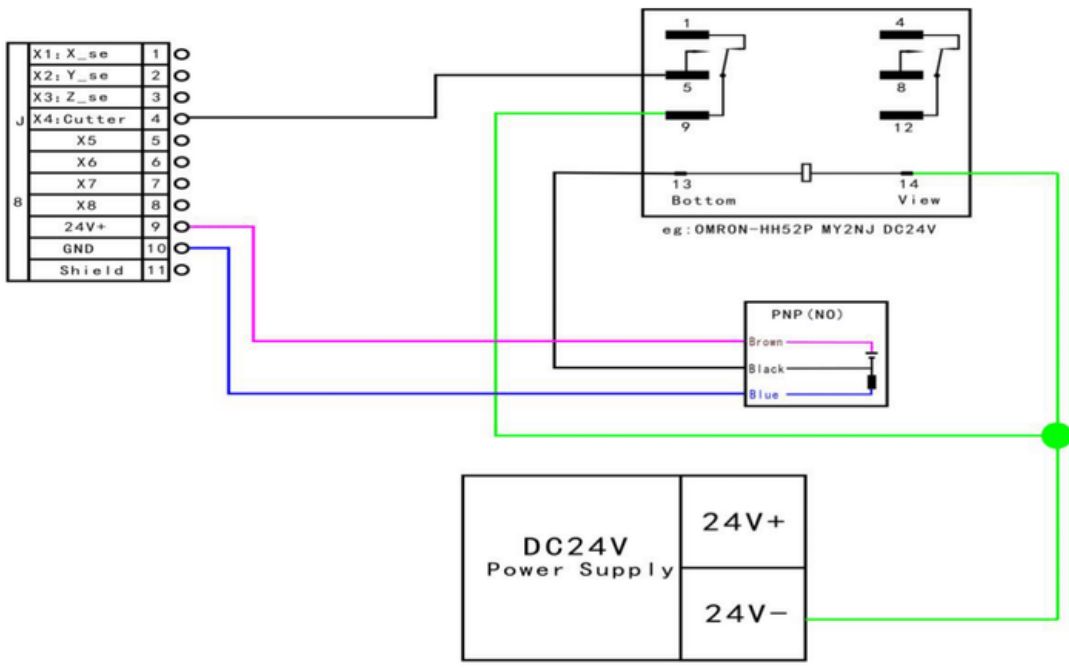

ADD.: Beijing haidian district shangdi three street jiahua building A308. P.C.: 100085.

Dell: 010-62970368 82923063. Fax: 82920078

2 Tool-setting input: Tool-setting detecting wiring:

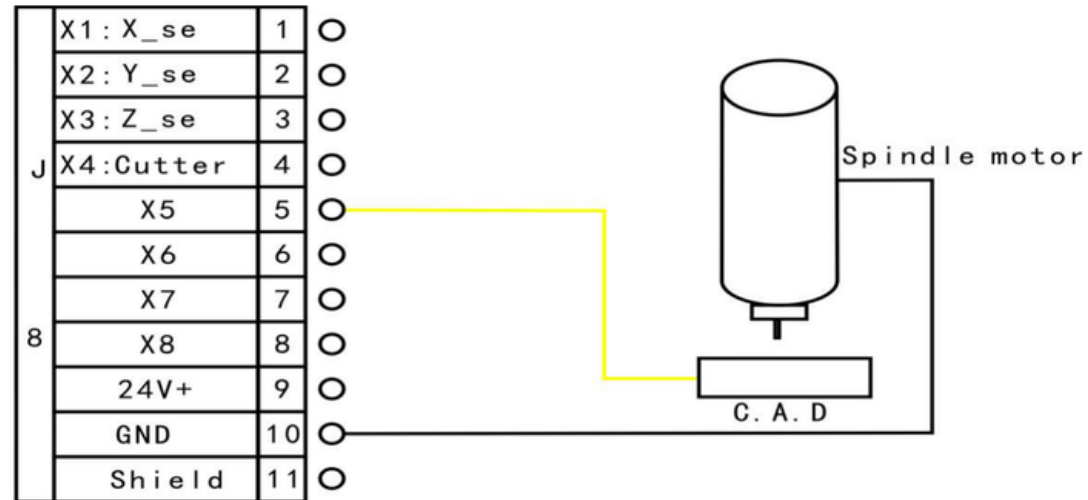

J10 Main power wiring:

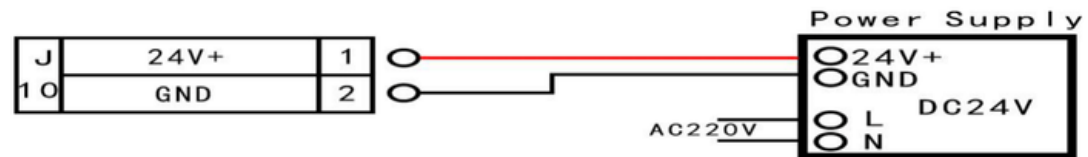

Output terminal: J2 X pulse signal wiring (Y, Z the same as X)

1 Stepper driver:

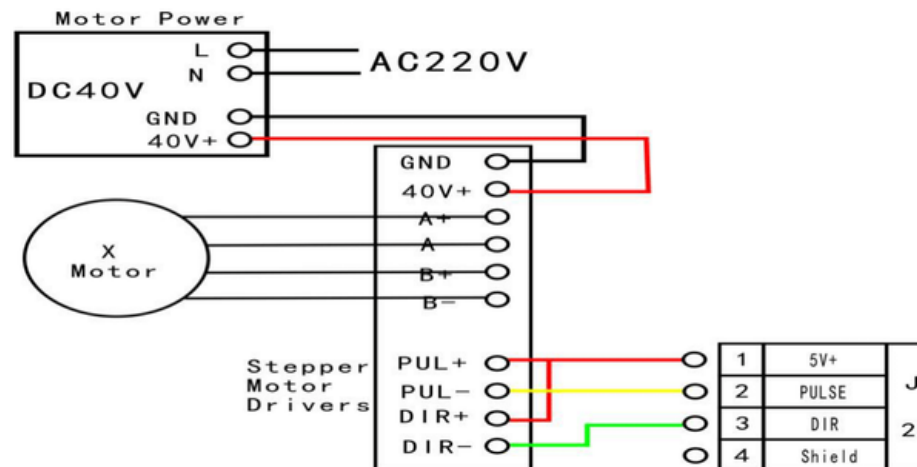

ADD.: Beijing haidian district shangdi three street jiahua building A308. P.C.: 100085.

Dell: 010-62970368 82923063. Fax: 82920078

2 Servo driver:

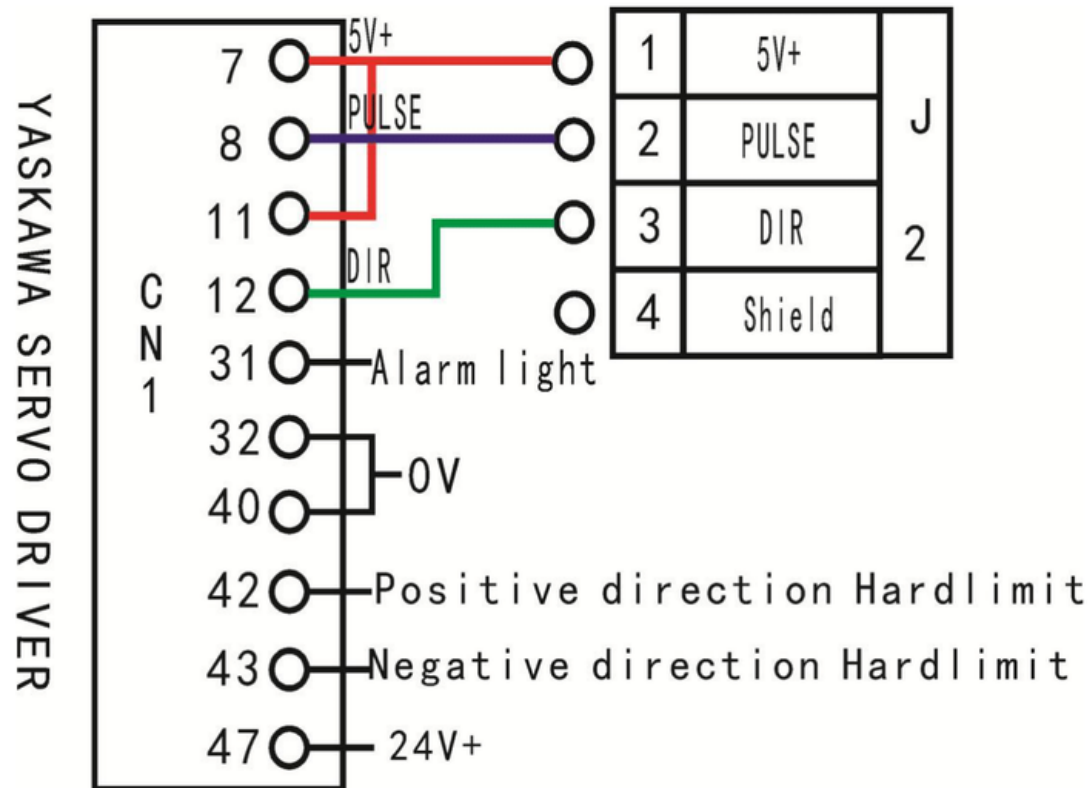

J7 Spindle inverter

2 status: spindle start/stop

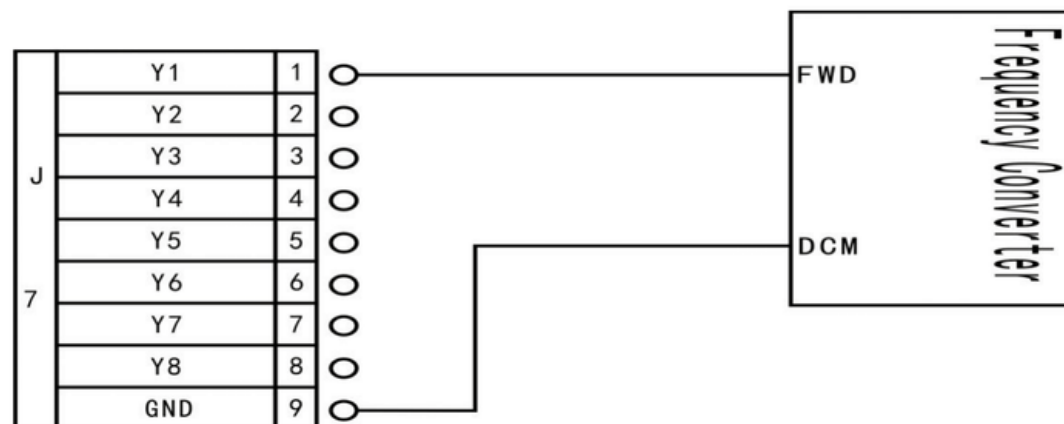

ADD.: Beijing haidian district shangdi three street jiahua building A308. P.C.: 100085.

Dell: 010-62970368 82923063. Fax: 82920078

The corresponding spindle setting is:

1 Shift	↓
2 Shift	↑

8 status: spindle start---S1—speed 1, S2—speed 2, Sn—speed n, when spindle stop, the screen displays Fn—the speed before spindle stop.

3 lines,8 status

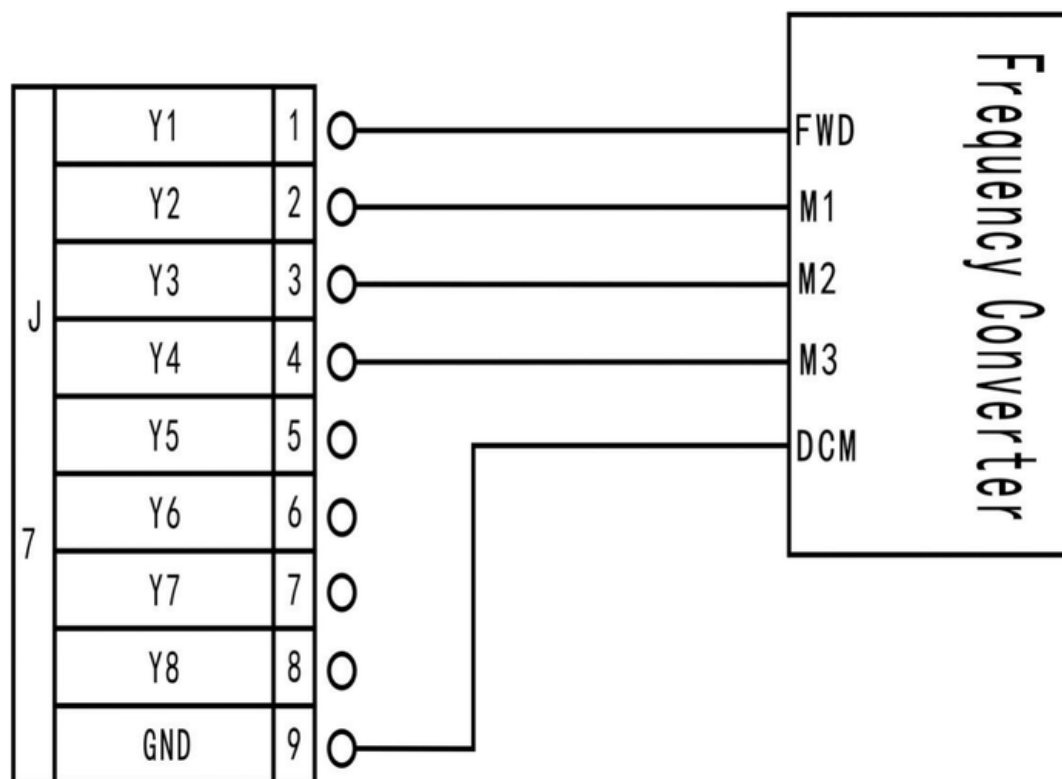

The corresponding spindle setting is:

1 Shift	↓	↓	↓
2 shift	↑	↓	↓
3 shift	↓	↑	↓
4 shift	↑	↑	↓
5 shift	↓	↓	↑
6 shift	↑	↓	↑
7 shift	↓	↑	↑
8 shift	↑	↑	↑

PS: FWD and DCM has Connected in Parallel in some inverters, please do not need to connect Y1 (S0) in such situations, you only need to connect DCM with GND of interface board, without having to re-set the spindle gear.

Output Y5-Alarm LED and Y6-WORK LED:

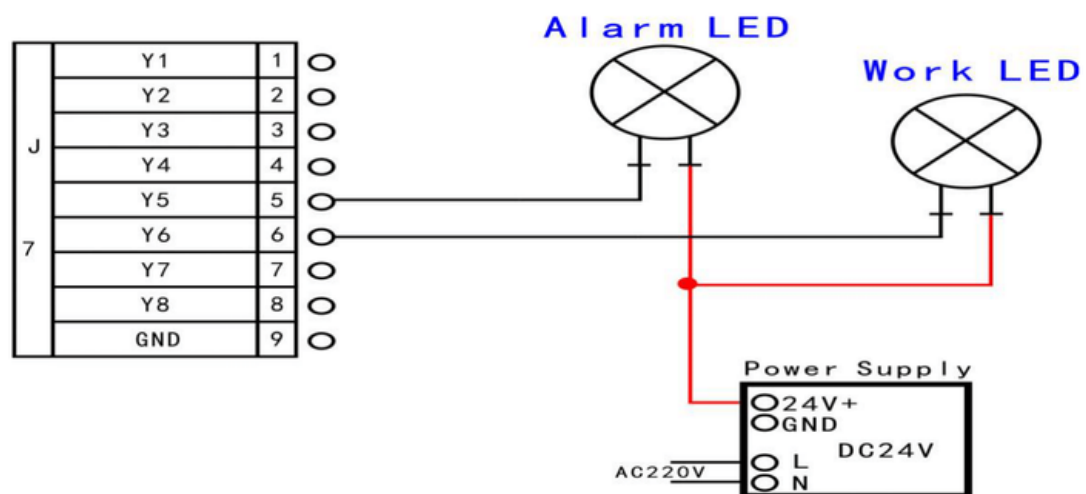

You can connect the machine with the control system when the above setting is over.

ADD.: Beijing haidian district shangdi three street jiahua building A308. P.C.: 100085.

Dell: 010-62970368 82923063. Fax: 82920078

3.4 Commissioning of The Machine and Control System

- 1) After turn on the power, you can manually run each axis movement and decide the direction. If the direction of movement and definition direction are opposite, you can set to change the motor phase sequence.
- 2) According to the original location of the machine coordinates, you can enter into menu-machine setting-home setting- home direction to reset it.
- 3) Double-press "menu"-manual voltage setup (the upper arrows stand for input voltage) to check whether the home switch is working.

The machine is in good connection if all the above setting is ok.

4. Menu direction

4.1 Menu category

According to menu function,RICHAUTO system menu can be divided into: **machine setup**、**auto pro setup**、**system setup**、**operate file**、**version view** , every main menu has corresponding submenus.

4.2 Menu detail

1. Machine setup:

Machine parameter setup is to set machine hardware. This parameter is set by machine producer according to device type. If machine hardware parameter is not change this parameter should not change. If machine user need to change, please dell

to machine producer.

Machine setup chart

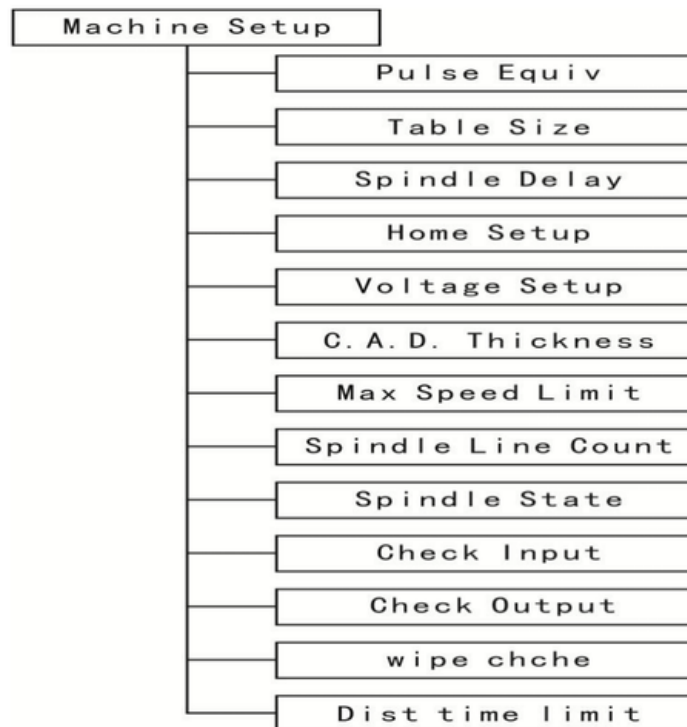

(1).pulse equiv:

The number of pulses of the system needs to send when machine moves every 1mm.Unit: pulse/mm.

1 stepper driver:

Ordinary axis formula = pulses per revolution / distance per revolution

Pulses per revolution formula: $(360^\circ/\text{stepper angle}) \times \text{Driver subdivision}$

Some stepper drivers mark pulse number directly.

ADD.: Beijing haidian district shangdi three street jiahua building A308. P.C.: 100085.

Dell: 010-62970368 82923063. Fax: 82920078

Distance/r formula:

Screw drive machine = screw pitch * mechanical transmission ratio

Rack drive machine = rack module * gear teeth number* π * mechanical transmission ratio

So stepper motor system formula:

Screw drive:



$$\text{pulse} = \frac{360^\circ}{\text{Stepper angle}} * \text{Driver subdivision} \\ \text{Screw pitch} * \text{transmission ratio}$$

Formula Description: step angle is the angle of the motor parameters, motor rotation step walk.

Driver subdivison is the parameter set by the driver.

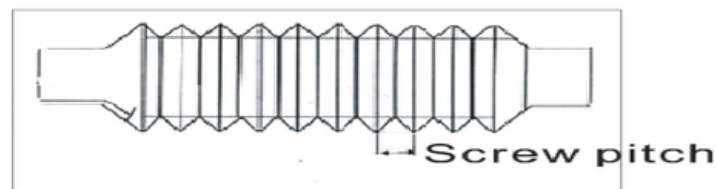

Screw pitch(above picture): The distance that the nut moves when the ball screw makes one rotation.

Transmission ratio: The speed ratio or angular velocity ratio of the capstan and the driven wheel.

ADD.: Beijing haidian district shangdi three street jiahua building A308. P.C.: 100085.

Dell: 010-62970368 82923063. Fax: 82920078

Rack drive:



$$\text{pulse} = \frac{\frac{360^\circ}{\text{stepper angle}} * \text{Driver subdivision}}{\text{rack module} * \text{gear teeth number} * \pi * \text{transmission ratio}}$$

Formula Description: step angle is the angle of the motor parameters, motor rotation step walk.

Driver subdivison is the parameter set by the driver.

Rack module and gear teeth number are gear parameters. rack module * gear teeth number* π equals the perimeter of the reference circle.

Transmission ratio: The speed ratio or angular velocity ratio of the capstan and the driven wheel.

Rotation axis formula = pulses per revolution / angles per revolution(360°)



$$\text{pulse} = \frac{\frac{360^\circ}{\text{stepper angle}} * \text{driver subdivision}}{360^\circ * \text{transmission ratio}}$$

Formula Description: step angle is the angle of the motor parameters, motor rotation step walk.





ADD.: Beijing haidian district shangdi three street jiahua building A308. P.C.: 100085.

Dell: 010-62970368 82923063. Fax: 82920078

Driver subdivison is the parameter set by the driver.

Transmission ratio: The speed ratio or angular velocity ratio of the capstan and the driven wheel.

setting:

choose "pulse equiv", Cursor in the X-axis pulse equivalent, click "", "" move cursor to be modified option, click "", press the number keys to enter values, press "" to save, cursor auto move to next line, in turn modify the Y, Z, A/C axis equivalent value. press "", save all value, back to "pulse equiv".

2 servo driver:

The pulse equivalent factory default X,Y,Z,A/C are 400, and set the electronic gear ratio in the servo drive according to the pulse equivalent.

The numerator of the electronic gear ratio represents encoder pulse number,you can search it in servo driver manual.

The denominator of the electronic gear ratio:

Ordinary axis:





1 screw drive: Handle pulse equivalent(400)* screw pitch * mechanical transmission ratio

2 rack drive: Handle pulse equivalent(400)*rack module * gear teeth number* π * mechanical transmission ratio

Rotation axis: Handle pulse equivalent(400)*360° * mechanical transmission ratio

(2). Table Size

RichAuto system make the table size as the soft limit values, in order to prevent machine move over travel, machine size must be less than or equal to the value of the actual motion displacement machine。

setting: Get into "table size", click " " or " " to move cursor to be modified, press " ", input modified number, click " " to save, cursor auto move to next line, in turn change **Y**、**Z**、**A/C** axis values, click " " to save all values, back to "table size"。

normal open, the same ↑ normal closed.

Upper and under arrows





Upper Arrows stand for input voltage setup:

Set input voltage signal terminal status. Input voltage top 5(0,1,2,3,4) corresponding to X zero point, Y zero point, Z zero point, A/C zero point, tool setting input signal terminal.

Under Arrows stand for input voltage setup:

Set output voltage signal terminal status. Output voltage top 4(0,1,2,3) corresponding to spindle on/off, multi-step 1, multi-step 2, multi-step 3 output voltage status.

Setting mode: Get into "input voltage setup" and "output voltage setup", press

"" and "" to control cursor to be modified . press "", "" to get to upper or under arrows, and press "" to change terminal status.

(6). C.A.D. Thickness:

This thickness should input by actual, when above actual Z axis will cut over, when low to actual Z axis can't touch workpiece. This parameter can only take effect when user use auto tool change function.

ADD.: Beijing haidian district shangdi three street jiahua building A308. P.C.: 100085.

Dell: 010-62970368 82923063. Fax: 82920078

(7). Max Spd Limit:

Set machine top speed, this set can only take effect when machine processing, system default max speed X,Y,A/C is "60000000", "Z+" is "1800", "Z-" is "3000".

Unit:mm/s.

(8). Spindle Line Count:

If line=3,Spindle Statues= $2^3=8$

(9). Spindle Statue:

When system using multi-step speed to control spindle, user should change this parameter. This parameters must corresponding to spindle output signal terminal wiring sequence. Detail setting please see "[spindle setup](#)".

(10). Check Input

1-4:X,Y,Z,A/C home signal 5 : tool setting input signal

(11). Check Output

1: spindle On/off signal 2-4: Spindle speed signal 5: Driver alarm signal

6: work LED signal

(12). Wipe Cache

Clear file fragmentation and error,operate it after system update.

(13). Distance mode time limit

You select distance mode, and if the machine never moves in a certain period of time (system default is 30 seconds), the system will go back to continuous mode.

2. Auto pro setup:

This set processing parameters and process files read property.

Auto pro setup menu structure

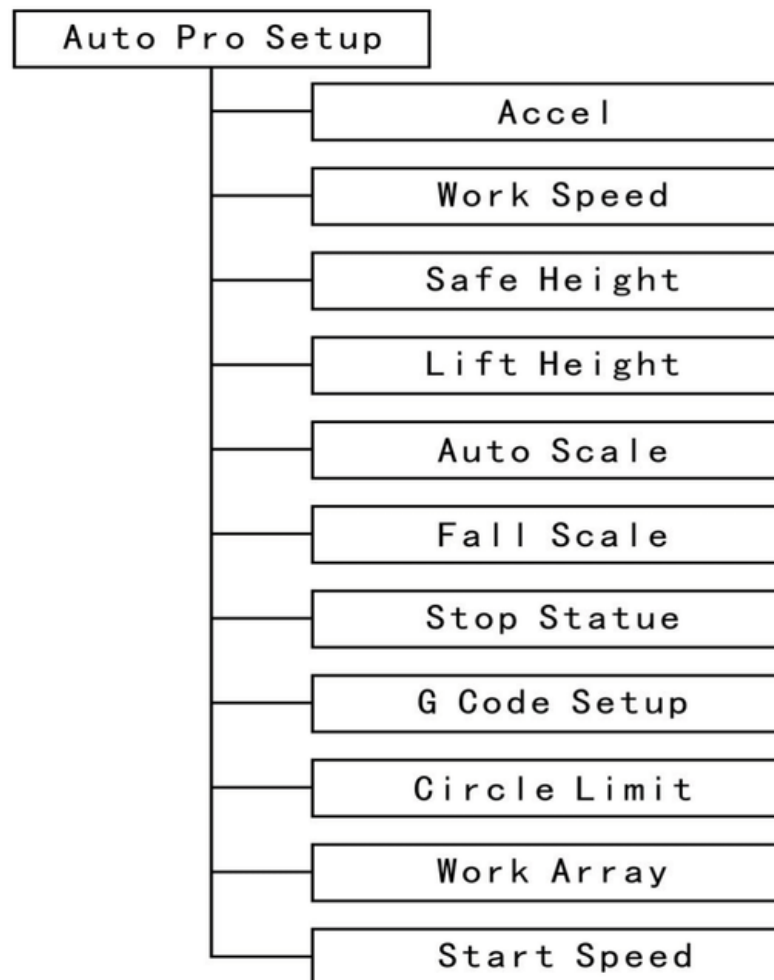

(1) acceleration :

This parameter can improve the ability to handling line and curve motion, unit:

mm/s² System default **acceleration** is 800.

(2) work speed:

Including work speed and fast speed. system default work spd is 6000;fast spd is 3000. unit:mm/min

(3) Safe height:

This parameter can tell us the height of the spindle will lift after processing or go to work origin. Unit: mm.

(4) Lift height:

This parameter can tell us the height of the spindle will lift after automatically tool setting. Unit: mm.

(5).Auto scale:



Auto pro speed=Auto scale*work speed,it does not affect the fast speed.

(6).Fall scale:

Include fall down scale and fall hight. system default fall down scale is 0.200,fall hight is 5.000mm. Fall down scale takes effect when the spindle falls to the fall height.

(7).Stop Statue: Setup stop position after auto pro.



Work stop state	
Finish action	Pick up
X Coordinate	0.000
Y Coordinate	0.000
Z Coordinate	0.000
A Coordinate	0.000

Setup stop position, press “” or “” to where to change

thenumber, and then press “” to input the number needed,

press “” to save.Press “” to get into finish action list

Pickup Z
Back to work origin
Back home
Back position
None move

press “” or “” to where to change the statue, and press

“” to save.

(8).G Code Setup:

Set special code read configure in G code , such as **M**、**T**、**F**、**I**、**J**、**K** , the detail please see "**G Code Setup**"

(9).Circle Limit:

System default circle limit is 1000.000.

(10).Work Array:

Setup array parameter,including columncount 、 rowcount 、 column space 、 row space、 interval (unit: ms) .

(11).Start Speed:

Reduce the noise of the low-frequency vibration of the motor, machine run smooth from stationary state to the work speed.

unit:mm/min, System default X,Y,Z,A/C start speed is 100.000 mm/min.

3. System setup:

System setup menu structure

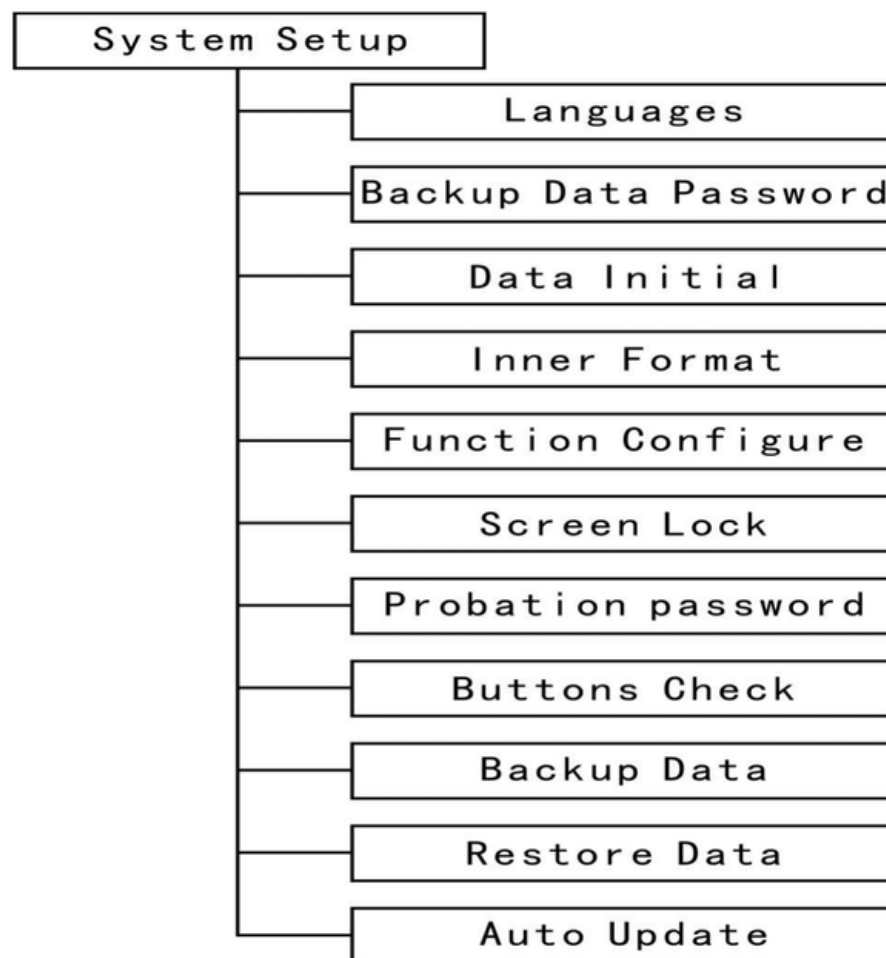

(1). Languages

Change system display language, choose Chinese and English.

(2).Backup Data Password

Prevent customers backup parameters which overwrite the original correct

parameters when by misoperation or when the system parameters disorder.

Cancel the password,when the display shows "input new password",do not input any number,and press button "OK".

(3). Data initial

After data initial system parameters will restore factory setting.

(4). Inner format:

Clear up inner files.

(5). Function configure:

Set system configure,including "Spindle lift or not when pause processing" , "Speed ratio influences fast speed or not" , "Mode-jog or follow" , "Proofread the code or not" , "Display processing parameter or not" , "Prompt back to origin or not" , "Safely processing or not" , "X axis reduction scale" , "Y axis reduction scale" , "Z axis reduction scale" , "A/C axis reduction scale" . You can choose the function you need,after changing the function,you need to restart the system.

(6). Screen Lock

The screen will lock when the time reaches to the number you setup. and then input the password to unlock the screen.

(7). Probation password

You can get a 20-digit-password from the website of ourcompany.

(8). Buttons check

Test the validity of the keyboard keys. Into test interface, the screen displays highlights when key take effect, no highlights when key is broken. Press "ok"+ "cancel" to quit.

(9). Backup Data

Back up menu parameters, format system can't effect this.

(10). Restore Data

Restore backup data to system.

(11). Auto Update

Update system online. Support the extension *******.PKG** update file.

4. Operate File

Advanced pro setup menu structures

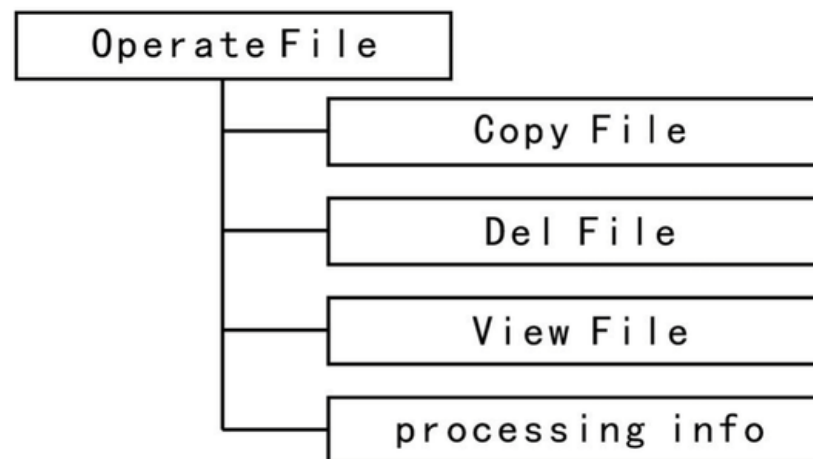

(1) Copy File

Copy files of U disk to Inner.

(2) Delete File

Delete files of inner.

(3) View File

View the files of U disk and inner.

(4) Processing information

Statistical the number of files processing successfully.

PS:Please pull out the U disk correctly after copying files from computer,if not,the controller may not recognize the U disk.

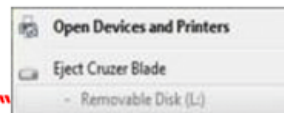
1. Win7(32 bit) system: after copying files,please press  **”,and then the**

display will show ””,choose the device to be shut down.when the display show



”,the U disk pull out from computer successfully.

2. Win XP system: after copying files,please press  **”,and then the display**

will show “ Safely remove USB Mass Storage Device - Drive(H:) ”,choose the device to be shut down.when the display show “ Safely Remove Hardware ”,the U disk pull out from computer successfully.

5. Version View

Include: ① Product ID eg: A0020112 ② Soft Version eg: A1.497

③ Emergency Version eg: A1.470 ④ Update Version eg: P1.440

⑤ Soft type

⑥ Hardware type

5. Machine operation

5.1 Return home

The handle will prompt “All Axis home”、“Z home only”、“none axis home” after starting, choose anyone you want.

In some cases, such as after the last normal shutdown, reboot and continue last operation, users don't need to reset machine, choose “none axis home”. That is because when system quit, it is auto save coordinate value.



5.2 Import processing files

Before processing, generally we should import files. There is 2 ways : U disk, inner file process.

1. Directly import processing files to U disk, we can be run.
2. Downloading files into handle by U disk.

5.3 Manual processing operation

Manual processing operation means we control machine by keyboard. For instance,

we can move X axis by pressing button “” or “”. Also we can change manual operation speed and slow or fast grid. After return home, system get into manual status, the screen displays:

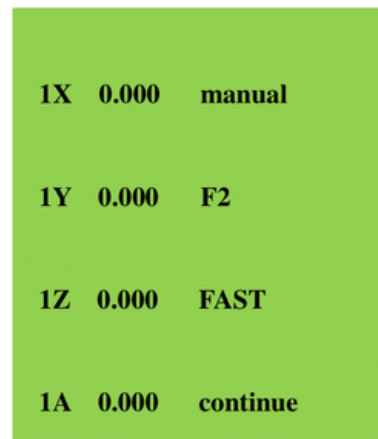





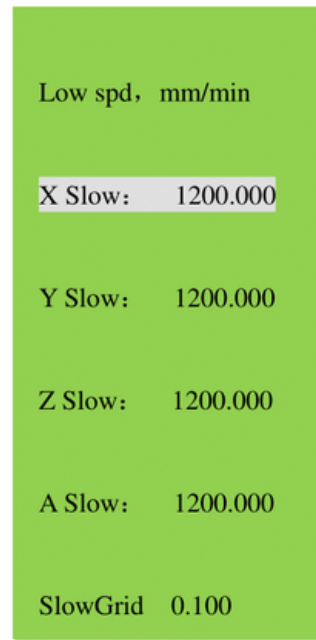

1. Manual operation speed adjust

There are two modes: fast speed and slow speed. We can change mode by

pressing button “”. The screen displays system default processing speed.

Speed adjust: in manual mode, press "cannel" to set the current speed mode. If current speed is low speed, it displays as followed:



The cursor in X axis low speed mode , press “” and “” move cursor to be modified , press “” that we can change value, press “” to save, press “” to quit. if number input is wrong, press “” to delete the last number.

In order to ensure the accuracy of processing and debugging, the system introduces the concept of grid. Other systems also call it minimum feed. Its range is: 0.05mm-1.0mm. when user change mode to step, machine will move by grid.

High speed mode setting is the same as low speed mode.









ADD.: Beijing haidian district shangdi three street jiahua building A308. P.C.: 100085.

Dell: 010-62970368 82923063. Fax: 82920078

2. Manual processing mode

In order to meet manual movement in different situation, this system provides 3 motion modes: continuous, step, distance. We can change mode by "MODE". The bottom of the screen can display which mode system is on.

1) Continuous motion mode

This mode is no special data control, in this mode, press direction key (、
、、、、、、) machine will move follow your operation, its speed is decided by current speed mode.









Notice : if user press key's time is too short (shorter than 0.5s), immediately lift buttons, machine will auto move to the nearest grid. It is always stop on grid when this motion mode is over. This motion mode is suitable for crude regulation machine coordinate situation.

2) Step motion mode

This mode is always run in low speed, move a grid per 0.5 second , its grid distance is decided by current speed mode. This motion mode is suitable for tool adjust or precise adjust machine coordinate situation.

3) Distance motion mode

This mode is run by distance which user is set(rotation axis run by angle). When

user press directory key (、、、、、、、
), machine will move by the setted distance.

Notice: Grid can't effect to this motion. It will move by set distance, can't move to grid point.

If user want to change distance, please change to distance mode, re-enter distance value is ok.





5.4 Automatic machining operation





Auto processing is means system deal files in U disk and inner by command, this is also called file processing。 Before auto processing, the parameters in system and machine must be correctly set.

Steps:

1) Determine the origin of the workpiece

The origin of the coordinate of XYZ in the processing program is the origin of workpiece. Before processing, we should connect the situation to the actual . The operation is as followed:









Move the machine to the situation where the file start processing. Press  +  to set the work origin of X Y axis. Press  +  ,you can choose to set the work origin of Z axis or A/C axis . If you use tool setting function, you

do not need to press “”+ “” to set work origin of Z axis, the key combination of tool setting is “”+“”.

2) Choose processing files

After determining the origin of workpiece, press “”, the following dialog box appears:



Press “” and “” to move the cursor, press “” to choose the situation, it will displays the first three files, press “” and “” to move cursor, press “” and “” to jump 2 lines, press “” to quit.









3) Processing parameters setting

ADD.: Beijing haidian district shangdi three street jiahua building A308. P.C.: 100085.

Dell: 010-62970368 82923063. Fax: 82920078





After choosing processing file press “” into setting processing parameters, including processing speed, travel speed, Z down ratio, speed ratio, spindle grad, pulse equivalent, and Z up distance.





Set work parameter
Workspeed 6000.000
Fastspeed 6000.000
Spindle Scale 1.000
Falldown Scale 0.200

Press “” and “” to move cursor to be modified, press “” to set, input value, press “” to save, press “” and “” to select the next. After modifying, press “” to save, system start checking files. It will start processing after checking system. Pulse equivalent there can only display can't be modified. If need to change, please back to “machine setup”. In processing, the screen will display current line, current speed, speed ratio, operating time. We can switch these option by pressing “”。

5.5 Processing operations

1) Adjust speed ratio and spindle grade

Adjust speed ratio In processing , press “” and “” can directly change speed ratio, current speed =setted work speed*speed ratio.each click “”, ratio down drop 0.1 and each click “”,ratio rise 0.1.Speed ratio max 1.0, min 0.1, the display speed will corresponding change, but time will not change.

Adjust spindle grade This function can take effect when system set multi-speed. In processing, press “” and “” to change spindle grade .Each click “”, up 1 grade, S8 is the top.Each click “”, drop 1 grade, till to S1.

2) Processing pause and adjust situation

In processing,Press “” to pause, top right corner of the screen will change “run” to “pause” , machine will stop running except spindle. Shown below:

1X	7.200	paus
----	-------	------

1Y	41.300	s-on
----	--------	------

1Z	-0.200	step
----	--------	------

User will start

In this time we can adjust situation of 3 axis, the default motion mode is step, speed is low, users can change situation, that is means machine will move a low speed grid each click; if we need quickly a large range adjust, change the speed mode to high by press “”, the motion mode change to continuous.

After that, press “”, shown :

1X	7.200	Paus
----	-------	------

1Y	41.300	S-ON
----	--------	------

1Z	-0.200	Step
----	--------	------

Restore Position

System will let users make sure whether to save the modified

Situation, press “”, system will back to situation before modifying; press

“”, system will start processing in modified situation.

3) Breakpoint processing and power-down protection

Breakpoint processing if user want to stop processing in middle , press



“STOP CANAEL” , shown below:

1X	7.200	RUN
1Y	41.300	F2
1Z	-0.200	1.0
Save break?		

System display “save break?”, if we want to save breakpoint, press “ORIGIN OK” , LCD

displays break list (total 8), press “X+ 1▲” or “X- 5▼” to choose position, and then

press “ORIGIN OK” to save , system auto home. If we want to continue processing from



breakpoint, we can choose key combination “RUN/PAUSE DELETE +1-8” , first hold on press “RUN/PAUSE DELETE” ,

the same time press number key (1-8) , release together, system will restore processing

from point 1. **If you want to fallback from the breakpoint,press “RUN/PAUSE DELETE” , input the**

line number,and then press “ORIGIN OK” ,the system will work from the new line number. Before restore process, system must have a home motion. eg: If we want to

continue processing from breakpoint, we can choose key combination “RUN/PAUSE DELETE” +

“” , first hold on press “” , the same time press “” , release together , system will restore processing from point 1 , the same as 2-8.

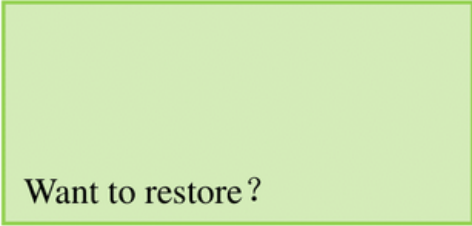

4) Power-down protection

when there is a sudden power failure during processing, system will save current



Want to restore?

coordinate and parameters, when power restart, process continue. Before that, system must have a home motion, after home, shown as below:

Press “” to continue unfinished process, it will display the stop line, press “” to cancel process.



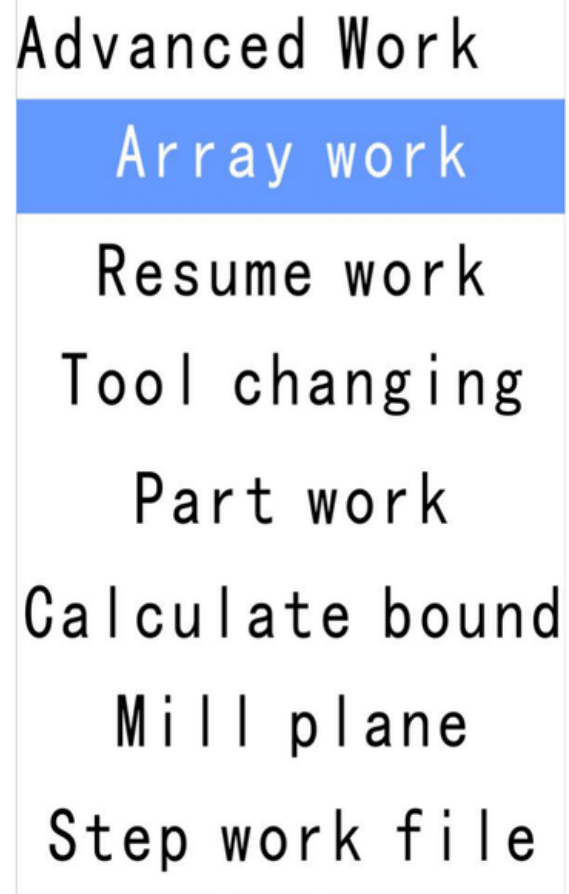

5.6 Advanced Processing

advanced processing is a function which is satisfied for some special request. It contains: Array work, Resume work, Tool changing, Part work, calculate bound, the

key combination is “” + “” , shown below:



1) Array work







1. press  and  move cursor to multiple process, press  to enter, press  and  to select different files;

2. Set process parameters, other operation is the same as general process, system start multiple processing according to users' set;

3. You can also setup in Auto Pro Setup – Work Array.

2) Resume work

First we should set multiple process parameters in “advanced setup”, then we can use this function。 Step is as below:

1.press “” and “” move cursor to Resume work, press “” to enter.press “” and “” to select different break points, and then press “”, system will restore processing from the break point.



3) Tool changing





Achieve manually change the tools in the position you set. Press “” get



Into the setup, and also press “” back to work origin.



4) Part work





Part work means users can select start line and end line, so part of the processing file can be processed. The step is as below:

①press “” to set, press “” and “” to move cursor to select different file list;

②press “” to enter, press “” and “” to select file, press “”, start to read the file.

③after read the file, press “” screen displays line 1 of the code, press “”, prompted “input start number: displays total lines”, input start line to



cursor, press  to confirm, if line number is wrong, press  to delete input number.



④ Press “” to the operation of the end line, the screen displays “input end number”, Press “” he screen displays the changed start number, press “”, Input end line in cursor, press “” to confirm, press “” to modification;

⑤Set processing parameters.

5) Calculate bound

Calculate area of the file.

① Press “” to set, press “” and “” to move cursor to select different file list;

② Press “” to get into file list, and then press “” and “” to choose file;

③ Press “”, start to read the file, after reading the file, the system will calculate the area.



6) Calculate bound



Including Scan Mill and Encircle Mill

The step is as below:

1 Scan Mill

① Press “” and “” to select different type.

② Press “” to get into the milling plane parameters, including scantype、width、height、diameter、depth and Z step.

Scan Mill Set	
ScanType	X Scan
Width	100.000
Height	100.000
Diameter	10.000
Depth	0.000
Z Step	0.100

Press "X+ 1▲" and "X- 5▼" to select the parameter to be setted, Press "RUN/PAUSE DELETE" to select scantype (**X Scan and Y Scan**) and the parameter, Press "ORIGIN OK" to save.

2 Encircle Mill

① Press "X+ 1▲" and "X- 5▼" to select different type.

② Press "ORIGIN OK" to get into the milling plane parameters, including scantype, width, height, diameter, depth and Z step.

Encircle Mill Set	
ScanType	AC
Width	100.000
Height	100.000
Diameter	10.000
Depth	0.000
Z Step	0.100



Press "X+ 1▲" and "X- 5▼" to select the parameter to be setted, Press "RUN/PAUSE DELETE" to select scantype (**clockwise and anticlockwise**) and the parameter, Press "ORIGIN OK" to save.

ADD.: Beijing haidian district shangdi three street jiahua building A308. P.C.: 100085.

Dell: 010-62970368 82923063. Fax: 82920078

7) Step work file

After setting the work origin,you can choose "step work file" to watch the effect of the processing,if it is not very well,you can stop the processing,and reset the work origin.

After choosing "step work file", Press " " to realize work step by step;Press " " to go back to auto processing.





PS 1. System automatically update

In the process of using handle, there may be some minor problems, these problems update handle software can be restored.

U disk update

This method is update by handle operation, don't need PC. Update files is *.PKG. Step is as below:

1、 Save update files to U disk, insert into handle.

2、 Press “”, select “system setup” press “” to enter, press “” and “” move cursor to “**system update**”。

3、 Press “” to enter, select “**U disk files**”, select update files suffix is *.PKG. System will auto update.

4、 After update, please restart the handle.

PS 2. Common troubleshooting

Solutions of the faults display on the screen

1 Indefinite screen flicker or automatically restart

Analysises and solutions:

- 1、 Power supply is insufficient. Check power supply if there are problems, and change high-quality power supply to solve the problems.
- 2、 The local power grid unstable. Check local grid voltage instability,or increase the the regulator filter device.
- 3、 There are something wrong with the power chip of the handle. This phenomenon also appears when the handle is powered through the USB cable to the computer,please return back the handle to our company.

2 Can not set working origin

Analysises and solutions:

- 1、 You may get into the mechanical coordinate system. Press the button "menu" + "1" to back to the first work coordinate system.
- 2、 The buttons are broken.menu-system setup- buttons check, to check the buttons are normal or not.

Faults in practical operation

1 The file size does not match the size of the actual set

Analysises and solutions:

- 1、 Pulse equivalent is wrong.
- 2、 You does not select the right tool.

2 The screen displays“beyond limit”when processing file

Analysises and solutions:

- 1、 The machine is not carried back to zero, the system is not able to confirm the actual position. Make the machine back zero.
- 2、 After setting the working origin, the reserved range is less than the actual file size .Determine the actual file size and set correct working origin.
- 3、 You set the wrong working origin in the file. Check the path of the file, and re-export the correct file.

3 Z axis (spindle) fall down abnormally (too fast) during processing

Analysises and solutions:

- 1、 Working speed beyond the fastest speed of Z axis. " Machine setup " - " Max speed limit ", set the speed to the safe speed.
- 2、 Coupling is loosing or transmission slippages. Re-adjustment the connecting parts.

- 3、 The lines connect the interface board with the motor drivers has disruption. Re-adjust the lines.
- 4、 Processing file error. Check processing file, try to download the correct processing file to U disk or handle internal.
- 5、 There is something wrong with the lines connectting Z axis motor and motor driver. Replace the lines.

4 Each time repeating the same processing file after backing to the machine origin , Z axis depth is not the same

Analysises and solutions:

- 1、 Machining countertop is uneven or processing object not firmly fixed, re-milling countertop adjust the flatness.
- 2、 Z-axis origin detection switch repeat positioning accuracy error, causing each Z axis homing error. Replace a high-quality detection switch.
- 3、 Too much interference in the Z-axis homing process to form a false origin. Re-adjust the line.

5 Back to the origin , the machine can not stop

Analysises and solutions:

Double click on the "menu" key, input signal (origin detection switch signal) self-testing, whether the detection signal is triggered or connect normally.

- 1、 The the origin detection switch is damaged. Replace a new one.

- 2、 The distance of the origin detection switch detection sheet beyond the detection range of the switch, adjust the position of the test piece.
 - 3、 The origin detection switch to the interface board wiring aging or loosening. Again check the connections.
 - 4、 The interface board is broken. Depot Repair.
 - 5、 50-pin data cable is broken. Replace it with a new data line.
- 6 Back to the machine origin , machinemove to the reverse direction

Analysises and solutions:

- 1、 The origin detection switch types do not match with the definition of the corresponding level. Modify the level. (Normally open type corresponds to a level defined the direction of the arrow down, normally closed type corresponds to the level defined arrow up)
- 2、 The origin detection switch is damaged. replace a new one.
- 3、 The origin detection switch connects interface board not well. Refresh the line to determine the wiring is correct.
- 4、 Too much interference, resulting in the illusion of the detection switch has been triggered. Recalibrated the whole circuit.
- 5、 The interface board is broken. Depot Repair.

6、 50-pin data cable is broken. Replace the data line.

7 Abnormally working when processing file or the actual file is different from theoretical file

Analysises and solutions:

- 1、 The program disorder.
- 2、 External interference is too large.Refresh connection. (separate strong electric from weak current, "GND" of inverter separated from the other components)

8 Start automatic tool setting, the tool does not stop after touching feeler bolock

Analysises and solutions:

- 1、 "cutter" signal line connects "X4" terminal not well.
- 2、 The "GND" terminal of interface board does not connect with spindle shell or connect not well.

9 Handle LCD digital changes, the machine does not move

Analysises and solutions:

If one axis is not moving, it may be a connection problem.Change another normal terminal to this terminal,if it is ok,the motor dirver is ok.Maybe there is something wrong with interface board、 50-pin cable. If it is still not moving, it is necessary to detect the

corresponding drive and motor.

If all axes are not moving ,firstly check if there are problems in the 50-pin cable and interface,secondly check the power supply of the motor drivers. Lastly, you have to check the mechanical part .

10 It is normal to the move from one location to another location, but when return from that position to the original position is not normal

Analysises and solutions:

Mechanical problems, screw may install not well.

Electrical components and wiring problem

1 an axis or multi-axis only one-way movement after handle power-on

Analysises and solutions:

- 1、 There is something wrong with the lines connect the interface board with the motor driver, check the connection.
- 2、 Interface board is damaged. Replace the interface board.
- 3、 The motor driver is damaged. Replace the driver.

2 The certain axis motor does not move after handle power-on

Analysises and solutions:

- 1、 Operator makes pulse line and direction line oppositely, rewiring it.
- 2、 5V common anode end of the motor driver disconnected, check the connection.
- 3、 The motor driver is damaged, operator can promote motor after handle power-on.
- 4、 The chip of the interface board damages, no pulse signal output.

3 Screen is not bright after handle power-on , and connected handle to computer with a USB cable the screen displays normal

Analysises and solutions:

- 1、 The handle does not connect to power supply. Check DC24V power supply output normal or not, if normal please check the cable from the power supply to the interface board.
- 2、 The 50-pin cable is damaged or the interface is broken.

4 Screen is not bright after handle power-on, and connect the handle to computer by USB cable,the screen is also not bright.

Analysises and solutions:

- 1、 This phenomenon may due to the handle shocked by external force or fall on the ground, causing the crystal processor damaged. Depot Repair.
- 2、 operator connect high voltage power supply, Depot Repair.

5 The screen display “spindle on”, actually the spindle off, the screen display “spindle off”, actually the spindle on

Analysises and solutions:

- 1、 There is something wrong with wires. organize your wires
- 2、 The output level definition is wrong. Modification correct output level definition.

6 Screen is not bright after handle power-on

Analysises and solutions:

- 1、 The power supply voltage is too big or the chip is broken because operator makes positive and negative of the power oppositely. Depot Repair.
- 2、 The power supply is damaged. Replace the power supply.
- 3、 50-pin data cable damaged. Replace the data line.
- 4、 handle 50-pin interface damage. Depot Repair.